

# RADIO-CRAFT

HUGO GERNSBACK, *Editor*

453

... AND IT'S A RADIO SET, TOO!

See Page 712

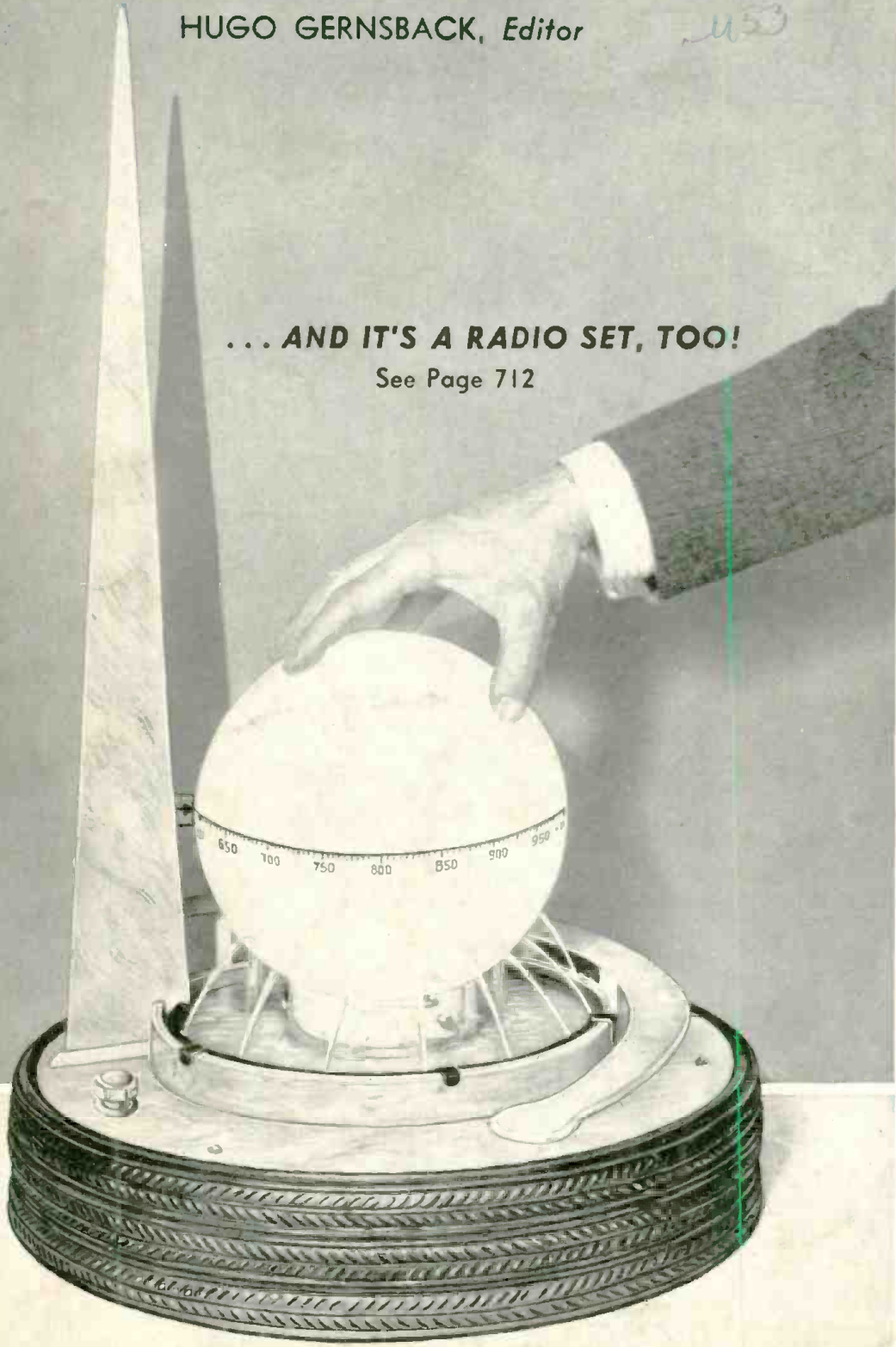

★  
**Announcing-**  
**\$4,000<sup>00</sup>**  
**PUBLIC ADDRESS**  
**CONTEST**  
★

SEE PAGE 722



**HOSPITAL TELEVISION**

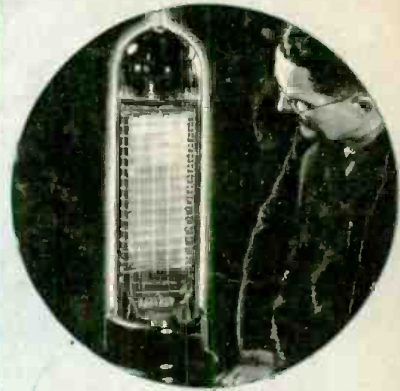

**2-FT. TRIODE!**

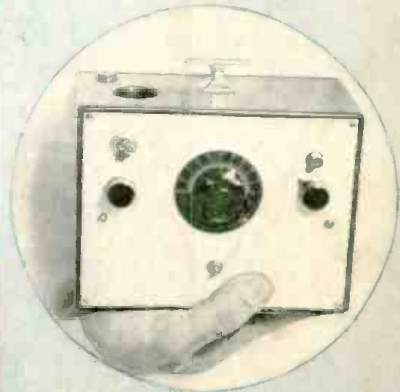

**2<sup>3</sup>/<sub>4</sub> LB. 5-TUBE SET**

**UNE RADIO'S GREATEST MAGAZINE**  
**25c**  
**FIXING COIN-PHONOGRAPHS • DOUBLE TRACE ON 'SCOPE**  
**RADIO AT WORLD'S FAIRS • SERVICING TELEVISION**

**FOR RADIO**

**FOR VIDEO**

**MICA** .00001 to 1 Mfd.

**MICA** 300 to 100,000 volts

**PAPER** .0001 to 10 Mfd.

**PAPER** 200 to 1,000 volts

**DYKANOL** .05 to 100 Mfd.

**DYKANOL** 600 to 150,000 volts

**WET AND DRY  
ELECTROLYTICS**  
2 to 5000 Mfd.

**WET AND DRY  
ELECTROLYTICS**  
25 to 600 volts

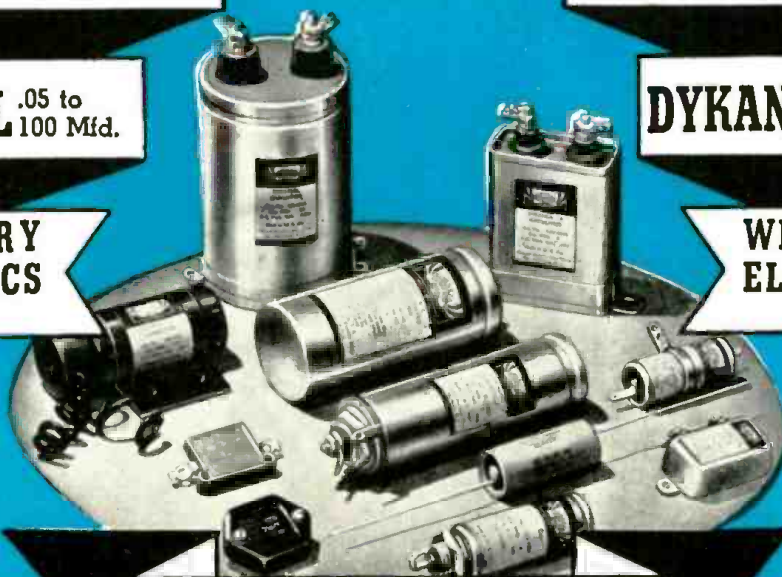

**FOR AUDIO**

Mica, Paper, Dykanol, Wet and Dry Electrolytics in any capacity and voltage combinations

## **CORNELL-DUBILIER CAPACITORS**

Standardized sizes, shapes, designs to meet every Radio and Electrical Requirement. Cat. No. 165A available on request.

*World's Largest Manufacturers of Capacitors*



**CORNELL-DUBILIER ELECTRIC CORPORATION**

1014 HAMILTON BOULEVARD • SOUTH PLAINFIELD NEW JERSEY



**J. E. SMITH, President**  
**NATIONAL RADIO INSTITUTE**  
 Established 25 years

He has directed the training of more men for the Radio Industry than anyone else.

# I will send you a Lesson Free to show how I train you at home in spare time for Good Jobs in Radio



**Broadcasting Stations**

Employ managers, engineers, operators. Installation and maintenance men for fascinating jobs and pay up to \$5,000 a year.



**Repairing Radio Sets**

Spare time set repair work pays many \$5, \$10, \$15 a week extra while learning. Full time servicing pays as much as \$30, \$50, \$75 a week.

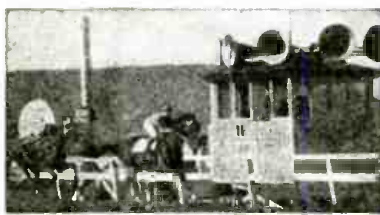

**Loud Speaker Systems**

Building, installation, servicing and operating public address systems is another growing field for men well trained in Radio.

## Lesson on Radio Servicing Tips FREE

I'll prove my Training gives practical, money-making information. Is easy to understand—just what you need to master Radio. My sample lesson text, "Radio Receiver Troubles—Their Cause and Remedy" covers a long list of radio receiver troubles in A.C., D.C., battery, universal, auto, T.R.F., superheterodyne, all-wave, and other types of sets. A cross reference gives you the probable cause and a quick way to locate and remedy these set troubles. A special section is devoted to receiver check-up, alignment, balancing, neutralizing and testing. You can get this lesson Free. No obligation.



**MAIL COUPON NOW**

**The Tested Way to BETTER PAY**

Clip the coupon and mail it. I will prove I can train you at home in your spare time to be a RADIO EXPERT. I will send you my first lesson FREE. Examine it, read it, see how easy it is to understand—how practical I make learning Radio at home. Men without Radio or electrical knowledge become Radio Experts, earn more money than ever as a result of my Training.

### Get Ready Now for Jobs Like These

Radio broadcasting stations employ engineers, operators, station managers and pay well for trained men. Fixing Radio sets in spare time pays many \$200 to \$500 a year—full time jobs with Radio jobbers, manufacturers and dealers as much as \$30, \$50, \$75 a week. Many Radio Experts open full or part time Radio sales and repair businesses. Radio manufacturers and jobbers employ testers, inspectors, foremen, engineers, servicemen. In good-pay jobs with opportunities for advancement. Automobile, police, aviation, commercial Radio, loud speaker systems are newer fields offering good opportunities now and for the future. Television promises to open many good jobs soon. Men I trained have good jobs in these branches of Radio. Read how they got their jobs. Mail coupon.

### Why Many Radio Experts Make \$30, \$50, \$75 a Week

Radio is young—yet it's one of our large industries. More than 28,000,000 homes have one or more Radios. There are more Radios than telephones. Every year millions of Radios get out of date and are replaced. Millions more need new tubes, repairs. Over \$50,000,000 are spent every year for Radio repairs alone. Over 5,000,000 auto Radios are in use; more are being sold every day, offering more profit-making opportunities for Radio experts. And RADIO IS STILL YOUNG, GROWING, expanding into new fields. The few hundred \$30, \$50, \$75 a week jobs of 20 years ago have grown to thousands. Yes, Radio offers opportunities now and for the future!

### Many Make \$5, \$10, \$15 a Week Extra in Spare Time While Learning

The day you enroll, in addition to our regular Course, I start sending Extra Money Job Sheets, show you how to do Radio repair jobs. Throughout your training I send plans and directions that make good spare time money—\$200 to \$500—for hundreds, while learning. I send you special Radio equipment to conduct experiments, build circuits. This 50-50 method of training makes learning at home easy, fascinating, practical.



I Also Give You This Professional Servicing Instrument

Here is the instrument every Radio expert needs and wants—an All-Wave, All-Purpose, Set Servicing Instrument. It contains everything necessary to measure A.C. and D.C. voltages and current; to test tubes, resistance; adjust and align any set, old or new. It satisfies your needs for professional servicing after you graduate—can help you make extra money fixing sets while training.

### You Are Trained for Television Also

With N.R.I. you take up Television principles right along with Radio principles—the correct method—since Television receivers combine both sight and sound. You also get more than ten text-books devoted entirely to Television.

### Get Sample Lesson and 64 Page Book Mail Coupon

Act Today. Mail the coupon now for sample lesson and 64-page book. They're free to any fellow over 16 years old. They point out Radio's spare time and full time opportunities and those coming in Television; tell about my training in Radio and Television; show you letters from men I trained, telling what they are doing and earning. Find out what Radio offers YOU! MAIL COUPON in an envelope, or paste on a postcard—NOW!

J. E. Smith, President  
 Dept. 9FX  
 National Radio Institute  
 Washington, D. C.

## HERE'S PROOF



**\$10 a Week in Spare Time**

"My work has consisted of Radio set servicing, with some Public Address Systems work—all in my spare time. My earnings in Radio amount to about \$10 a week."—WILLIAM MEYER, 705 Ridge Road, Hobart, Ind.



**Earnings Tripled by N. R. I. Training**

"I have been doing nicely, thanks to N.R.I. Training. My present earnings are about three times what they were before I took the Course. I consider N.R.I. Training the finest in the world."—BERNARD COSTA, 952 Manhattan Ave., Brooklyn, N. Y.

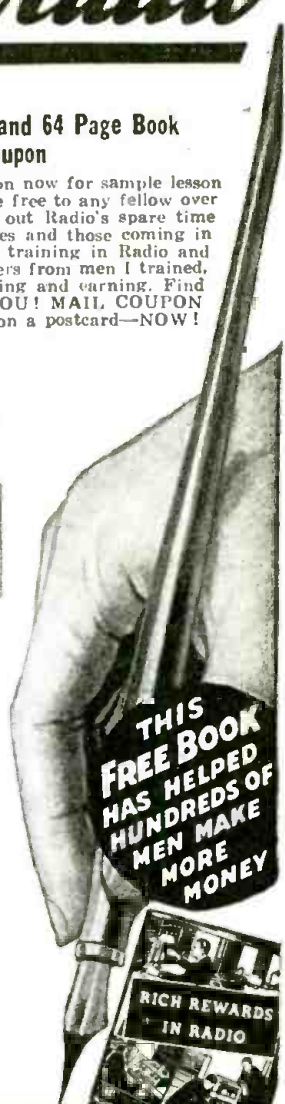

## Good for FREE SAMPLE LESSON and BOOK on RADIO'S OPPORTUNITIES

J. E. SMITH, President  
 National Radio Institute, Dept. 9FX  
 Washington, D. C.

Dear Mr. Smith: Without obligation send me free the Sample Lesson and your 64-Page Book "Rich Rewards in Radio," telling about spare time and full time Radio opportunities, and how I can train for them at home in spare time. (Please write plainly)

Name ..... Age .....

Address .....

City ..... State .....

# RADIO-CRAFT

HUGO GERNSBACK, *Editor-in-Chief*

N. H. LESSEM  
*Associate Editor*

THOS. D. PENTZ  
*Art Director*

ROBERT EICHBERG  
*Trade Digest Editor*

R. D. WASHBURNE, *Managing Editor*

## Contents JUNE, 1939 Issue

VOLUME X -- NUMBER 12

|   |                                     |     |
|---|-------------------------------------|-----|
| Editorial: Television Angles.....   | Hugo Gernsback                      | 709 |
| The Radio Month in Review.....  |                                     | 710 |
| "For Display Purposes Only!" . . . . But A Good Money-Maker<br>for Servicemen.....            | Joseph H. Kraus & Howard G. McEntee | 712 |
| Servicing Television Receiver Faults—Part I.....  | S. West                             | 714 |
| How to Build a Tiny 2¾-Pound 5-Tube Battery-Portable Broadcast<br>Superhet. ....              | Howard G. McEntee                   | 716 |
| This Home—"Wired for Radio"—Part IV (Conclusion)..  | N. H. Lessem                        | 718 |
| Radio—at the World's Fairs.....   |                                     | 720 |
| \$4,000 Public Address Contest.....   |                                     | 722 |
| Seel Hear!—American Teleceivers for 1939.....   |                                     | 723 |
| Servicing Coin-Operated Phonographs—No. 1.....  | Sanford Miller                      | 724 |
| Build This Switchless 2-Way Interphone!.....  | A. C. Shaney                        | 726 |
| New Circuits in Modern Radio Receivers—No. 21....   | F. L. Sprayberry                    | 728 |
| Easily Assembled "Electric Eye" Kit.....  | M. N. Beitman                       | 729 |
| Radically New! Combined Photocell-Relay.....  | Henri F. Dalpayrat                  | 729 |
| Double-Tracing Your Oscilloscope.....   | Harl O. Piety                       | 730 |
| Useful Kinks and Circuits.....  |                                     | 732 |
| The Beginners' Simple Volt-Milliammeter.....  | C. W. Redstone                      | 733 |
| Servicing Questions & Answers.....  |                                     | 734 |
| Operating Notes .....   |                                     | 734 |
| The Latest Radio Equipment.....   |                                     | 735 |
| Combined A.C.-D.C.—Battery Portable.....  | K. Matero                           | 738 |
| Radio Trade Digest.....   |                                     | 739 |
| <b>RADIO SERVICE DATA SHEETS:</b>   |                                     |     |
| No. 254—RCA Victor ("Little Nipper—the 2nd") Models 9TX-1,<br>9TX-2, 9TX-3, 9TX-4, 9TX-5..... |                                     | 743 |
| No. 255—General Electric Model GB-400 Battery Portable.....                                   |                                     | 745 |
| Book Reviews .....  |                                     | 707 |

### In the NEXT ISSUE

How to Make and Use a  
Frequency Wobbler  
Tuning With a Rheostat!  
Public-Address Amplifier  
Circuit Features  
"B"-Batteryless Drycell Ra-  
dio Set!  
The Direct-Coupled Ampli-  
fier — Brought Up-to-  
Date

★

### "FOR THE FIRST TIME . . .

. . . in any radio magazine."

Again Radio-Craft brings a "first" to its readers! This time, it's the description of "The Orchestra of Tomorrow," in which the orchestra leader, by means of remote controls on his director's stand, actually adjusts the volume of given musical instruments—all of them electronic—to suit a particular desired overall pattern, and also varies the overall volume of this pattern to suit the dynamic mood of the rendition.

Read about the 10-piece CRACRAFT ELECTRONIC ORCHESTRA (now rehearsing in New York City)—  
—in JULY RADIO-CRAFT

And AGAIN a Radio-Craft "first"! A construction article that set builders will go for in a big way. Don't miss the R. D. Washburne-G. E. Archenbronn article on a battery-powered, portable or semi-portable, combined WIRELESS or non-wireless radio receiver, public-address unit, hearing aid, electric phonograph and "personalized" (or "silent") radio set (for sick-room use, etc.).

Read about the new wireless "portable set of tomorrow" described—  
—in JULY RADIO-CRAFT

★

Published by Radcraft Publications, Inc. Publication office: 29 Worthington Street, Springfield, Mass. Editorial and Advertising Offices: 99 Hudson Street, New York City. Chicago Advertising Office: RADIO-CRAFT, 520 North Michigan Avenue, Chicago, Ill.

RADIO-CRAFT is published monthly, on the first of the month preceding that of date; subscription price is \$2.50 per year in U. S. and Canada. (In foreign countries, \$3.00 a year to cover additional postage.) Entered at the post office at Springfield as second-class matter under the act of March 3, 1879.

Foreign Agents:

London—Gorrings's American News Agency, 9A Green St., Leicester Square, W. C. 2, England.  
Paris—Messageries Dawson, 4 Rue Faubourg, Poissonniere, France.  
Melbourne—McGill's Agency, 179 Elizabeth St., Australia.  
Dunedin—James Johnston, Ltd., New Zealand.

★

Text and illustrations of this magazine are copyright and must not be reproduced without permission of the copyright owners.

★

Copyright 1939 Radcraft Publications, Inc.

## BOOK REVIEWS

**PRINCIPLES OF RADIO**, 3rd Edition, by Keith Henney (1938). Published by John Wiley & Sons, Inc. Size 5½ x 8 ins., cloth covers, 495 pages, 311 illustrations. Prepared in textbook style, with examples and problems. Price \$3.50.

Keith Henney, well-known author of books technical, has completed the 3rd edition of a work instituted 8 years ago. Due to extensive revisions, the book may be considered almost completely rewritten. Anyone starting in radio will find the book an up-to-date reference to its bases.

The radio art is moving forward rapidly on many fronts, and a book such as "Principles of Radio" is an invaluable aid in keeping the radio man's feet on the ground.

Chapter headings follow:

Fundamentals; Ohm's Law; Production of Current; Inductance; Capacity; Properties of Alternating-Current Circuits; Resonance; Properties of Coils and Condensers; The Vacuum Tube; The Tube as an Amplifier; Audio Amplifiers; Design of Audio-Frequency Amplifiers; High-Frequency Amplifiers; Detection; Receiving Systems; Rectifiers and Power Apparatus; Oscillators, Transmitter, etc.; Antennas, Transmission, etc.; Facsimile and Television Transmission.

**MOTION PICTURE SOUND ENGINEERING**, by the Research Council of the Academy of Motion Picture Arts and Sciences (1938). Published by D. Van Nostrand Company, Inc. Size, 6 x 9 ins., cloth cover, 372 illustrations, 547 pages. Price \$6.50.

"Motion Picture Sound Engineering" constitutes the book form of a series of lectures presented to the classes enrolled in the courses in sound engineering given by the Research Council of the Academy of Motion Picture Arts and Sciences, Hollywood, Calif.

We second the opinion of the Council's chairman Koenig that "this book will become a valuable addition to the technical literature on the motion picture and we offer it to the industry with a feeling of great pride."

Even owners of the lowly home and industrial 16-millimeter talkies can learn much from this book as its following contents listing indicates:

Basis of Motion Picture Sound; The Nature of Sound; Types of Film Recording; Noise Reduction; Re-Recording and Preparation for Release; Microphones; Headphones and Loudspeakers; Film Drive; Film Processing; Reproducing Systems; Sound Circuits; Measurements in Sound Circuits; Phase Distortion; Transformers for Sound Circuits; General Network Theory; Attenuation Equalizers; Equalizer Design; Wave Filter Theory; Low-Pass and High-Pass Filters; Dividing Networks for Loudspeaker Systems; Vacuum Tubes; Amplifier Circuits; Rectifiers; Volume Indicators; Elementary Considerations; Static Electricity; Direct Currents; Electrical Power and Energy; Magnetism; Electro-Magnetism and the Magnetic Circuit; Electro-Magnetic Induction; The Decibel; Resistance Attenuation Networks; Generators and Motors; Alternating Currents; Vector Notation; Resonant Circuits; Vacuum Tubes; Triode Amplifiers.

**THIS IS LIFE**, by Boake Carter. Published by Dodge Publishing Co. 5¼ x 8 ins., cloth covers, 245 pages. Price \$1.75.

"This Is Life," a book of the easily readable type, by Philco's former commentator, has little in it of technical interest, but it certainly has appeal for the listener-in and for those among the 350,000 people in the technical radio field who like some light reading once in a while which touches on their chosen profession.

We quote a half-dozen chapter titles as follows: "Roaring Waters," "Landslide," "G-Men," "SOS," "Peanut Politicians," "I Do!"

Material was prepared with the cooperation of CBS, Philco, the New Jersey State Police, United Press, United Airlines, TWA, FBI, and certain other publishing and technical groups.

This is a library table reading book.

**TELEVISION RECEPTION TECHNIQUE**, by Paul D. Tyers (1937). Published by Sir Isaac Pitman & Sons, Ltd. (London, England), available from Pitman Publishing Corp., New York. Size, 5½ x 8½ ins., cloth covers, 144 pages, 85 illustrations. Price \$4.00 (12s. 6d.).

Unlike the majority of preceding books on the subject of television the treatment of this new book is from an engineering angle. For this

reason it receives the approval of *Radio-Craft* as being one of the most worthwhile publications in television literature.

Of especial value and importance are the photographs of actual images which illustrate technical points discussed in the text.

The outstanding technical merit of this book outweighs limitation of treating the subject only of Britain's television service. Chapter headings are as follows: The Basic Principles, Aerial Systems, Signal Amplification, Cathode Tube Practice, Time Base Circuits, Synchronizing Circuits, The Vision Receiver, Vision Receiver Faults, Appendix.

**GERNSBACK'S EDUCATIONAL LIBRARY SERIES**, Hugo Gernsback (1938). Published by Radio Publications. Size 5 x 6½ ins., paper covers, illustrated, 32 pages. Price 10c each.

The following 4 books make available to the beginner in radio the long-needed information of just how to go about approaching its ABC's; including the reading of diagrams, and performing experiments purely for their entertainment values.

No. 5—BEGINNERS RADIO DICTIONARY is the first in the series, and it takes all of the sting out of radio articles that bristle with words unfamiliar.

No. 6—HOW TO HAVE FUN WITH RADIO "All work and no play makes Jack a dull boy" is a truism for radio men as well as those in any other field.

The entertainment side of radio is excellently served with the contents of this book. The titles of easily performed amusements follow:

"Talking Newspaper; Talking Gloves; Radio Electric Chair; Visual Music; Dancing to Silent Music; Musical & Talking Gadgets; The Radio Dancer; Hearing Radio Through Your Teeth; Radio Burglar Alarm; Home Broadcasting; The Door that Talked; Home Recording; Making a Real Telephone with Radio; The Reluctant Radio; 'No-power' Radio Set."

No. 7—HOW TO READ RADIO DIAGRAMS As this reviewer soliloquized some time ago, "formulas are really the short-hand of radio." In order that the radio beginner may familiarize himself with schematic circuits which disclose in brief the complicated arrangement of various pieces of apparatus, he can do no better than to study this course in radio's shorthand.

The diagrams are broken down both pictorially and symbolically which makes the reading of diagrams "apple pie."

No. 8—RADIO FOR BEGINNERS This reviewer is tempted to add to the title the subtitle "Radio Made Easy by Analogies", for this book, small as it is, covers a considerable amount of ground in making the reader familiar with the elementary principles of radio. Analogies are drawn between these technical principles and everyday occurrences with which everyone is familiar; such as, throwing a rock into a pool of water and then analyzing the resulting waves with regard to the progression of radio signals through the ether.

**POLICE COMMUNICATION SYSTEMS**, by V. A. Leonard (1938). Published by University of California Press. Size, 5½ x 8½ ins., cloth cover, illustrated, includes an extensive appendix (including a chapter on existing radio legislation), and bibliography. Price \$5.

The present head of the police communication systems at Fort Worth, Texas, has prepared a comprehensive book which merits a place in the library of every radio man interested in possessing a complete book file on technical radio subjects.

Fourth in a group dealing with the administration of criminal justice, "Police Communication Systems" takes its place as an initial and extensive work incorporating police radio operation in all its phases.

Chapter headings: The Beginnings of Modern Police Communication; The Modern Police Telephone System; The Beat and Its Equipment; The Police Radio System; Radio Patrol Operation; The Regional Police Communication System; The Police Teletype Network; Burglar- and Holdup-alarm Systems; Coordination of the Police Communication System; Police Communication under Disaster Conditions; Police Communication and Distant Identification; The Modern Police Communication System; Foreign Police Communication Systems; Conclusion.

# TRAIN FOR ELECTRICITY

## 12 WEEKS TRAINING

### THIS QUICK EASIER WAY

#### ACTUAL SHOP WORK—NOT BOOKS



## WANT TO EARN MORE MONEY?

Have you ever dreamed of holding down a steady, good pay job? Have you ever dreamed of doing the work you really like in a job that holds promise of a real future in the years ahead?

Well, we all know that you can't get the good things in life by just dreaming about them. Hundreds of fellows are today holding down mighty fine jobs with prospects of a bright future. They are filling these jobs because they had the foresight to equip themselves with the right kind of training. Most of these men were only average fellows a short time ago, but the proper training helped to lift them out of the low pay ranks of unskilled workers. The same opportunity is now offered to you.

## RADIO 4 WEEKS

AN EXTRA Course Included

Right now I am including at no extra tuition cost, an extra 4-weeks course of training in Radio after you have completed your 12 weeks electrical training.

The great fascinating field of ELECTRICITY offers a real future to many men and young men who are willing to prepare for a place in this giant industry.

## LEARN BY DOING

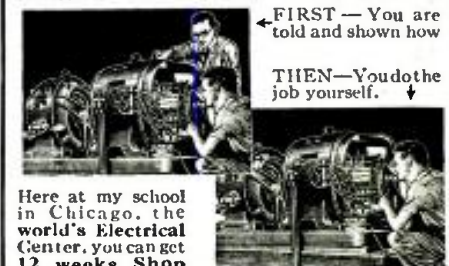

← FIRST — You are told and shown how

THEN — You do the job yourself. ↓

Here at my school in Chicago, the world's Electrical Center, you can get 12 weeks Shop Training in ELECTRICITY, that can help give you your start towards a better job.

You will be trained on actual equipment and machinery and because of our method of training, you don't need previous experience or a lot of education. Many of my successful graduates never even completed Grammar School.

Right now I'm including valuable instruction in Diesel, Electric Refrigeration and Air Conditioning at no extra cost. Our practical shop methods make it easier to learn—First the instructors tell you how a thing should be done—then they show you how it should be done—then you do the actual work yourself.

## I'LL FINANCE YOUR TRAINING

You can get this training first—then pay for it later in easy monthly payments, starting 60 days after your 12 weeks training period is over—then you have 12 months to complete your payments.

## GET THE FACTS

Send the coupon today for all details. When I get it I'll send you my big free book containing dozens of pictures of students at work in my shops. I'll also tell you about my "Pay After Graduation" plan, how many earn while learning and how we help our students after graduation. Fill in, clip coupon, mail today for your start toward a brighter future.

**COYNE ELECTRICAL SCHOOL**  
500 S. Paulina St., Dept. 69-78, Chicago, Ill.

H. C. LEWIS, Pres., COYNE ELECTRICAL SCHOOL  
500 S. Paulina St. Dept. 69-78, Chicago, Ill.

Dear Mr. Lewis: Without obligation send me your big, free catalog with facts about Coyne Training and details of your "Pay-Tuition-After-Graduation" Plan and your 4 weeks extra Radio Course.

Name.....Age.....  
Address.....  
City.....State.....

Please Say That You Saw It in RADIO-CRAFT

# For Better Servicing - - For Bigger Profits - - Use Gernsback Manuals and Books!



**S**INCE 1931 Servicemen have been buying more GERNSBACK OFFICIAL RADIO SERVICE MANUALS year after year. The authentic material, easily accessible diagrams and complete service data make them invaluable to dealers and radio Servicemen. *Without a Gernsback Service Manual at the repair job, there's time and profit lost.* Your service kit or laboratory is incomplete without all the GERNSBACK OFFICIAL RADIO SERVICE MANUALS. There are GERNSBACK MANUALS for servicing auto-radios, also refrigeration and air conditioning equipment.

**VOLUME 7 OFFICIAL RADIO SERVICE MANUAL**  
Over 1,800 Pages • Over 3,000 Illustrations • Stiff, Leatherette, Looseleaf Covers • Size 9 x 12 Inches • Net Weight 10½ lbs. **\$10.00**

**1936 OFFICIAL RADIO SERVICE MANUAL**  
Over 1,200 Pages • Over 2,500 Illustrations • Stiff, Leatherette, Looseleaf Covers • Size 9 x 12 Inches • Net Weight 8 lbs. **\$7.00**

**1935 OFFICIAL RADIO SERVICE MANUAL**  
Over 1,000 Pages • Over 3,000 Illustrations • Flexible, Leatherette, Looseleaf Covers • Size 9 x 12 Inches • Net Weight 3¾ lbs. **\$7.00**

**1935 OFFICIAL AUTO-RADIO SERVICE MANUAL**  
Over 240 Pages • Over 500 Illustrations • Flexible, Leatherette, Looseleaf Covers • Size 9 x 12 Inches • Net Weight 1¾ lbs. **\$2.50**

**1934 OFFICIAL RADIO SERVICE MANUAL**  
Over 400 Pages • Over 2,000 Illustrations • Flexible, Leatherette, Looseleaf Covers • Size 9 x 12 Inches • Net Weight 2½ lbs. **\$3.50**

**1932 OFFICIAL RADIO SERVICE MANUAL**  
Over 1,000 Pages • Over 2,000 Illustrations • Flexible, Leatherette, Looseleaf Covers • Size 9 x 12 Inches • Net Weight 4½ lbs. **\$5.00**

**OFFICIAL REFRIGERATION SERVICE MANUAL (Volume I)**  
Over 350 Pages • Over 1,200 Illustrations • Flexible, Leatherette, Looseleaf Covers • Size 9 x 12 Inches • Net Weight 2½ lbs. **\$5.00**

**OFFICIAL REFRIGERATION SERVICE MANUAL (Volume II)**  
Over 352 Pages • Over 300 Illustrations • Flexible, Leatherette, Looseleaf Covers • Size 9 x 12 Inches • Net Weight 1½ lbs. **\$5.00**

**OFFICIAL AIR CONDITIONING SERVICE MANUAL**  
Over 352 Pages • Over 600 Illustrations • Flexible, Leatherette, Looseleaf Covers • Size 9 x 12 Inches • Net Weight 2½ lbs. **\$5.00**

*To order these famous Manuals, see or write to your jobber or favorite mail order house. If more convenient, mail coupon directly to publishers.*

**RADCRAFT PUBLICATIONS, Inc.**  
99 HUDSON STREET NEW YORK, N. Y.

Get into the swing of reading instructive, authoritative books on technical subjects—radio, air conditioning and refrigeration. It's the easiest, quickest and most inexpensive way to improve your knowledge on these topics. In this series, popularly known as the RADIO-CRAFT LIBRARY SERIES, are all the titles necessary to your personal advancement. Only by careful study of these enlightening books, can you gain adequate experience in fields of radio, air conditioning and refrigeration. Each book is uniform. The volumes measure 6 x 9 inches—contain 64 pages, and have stiff, flexible covers. PRICE 50c PER BOOK. All books are sent to you postpaid.

### Here Are The Titles:

- |  |   |
|--|---|
| Book No. 2<br>MODERN VACUUM TUBES                      | Book No. 15<br>ABC OF REFRIGERATION                 |
| Book No. 3<br>THE SUPERHETERODYNE BOOK                 | Book No. 16<br>PRACTICAL RADIO CIRCUITS             |
| Book No. 6<br>BRINGING ELECTRIC SETS UP-TO-DATE        | Book No. 17<br>SERVICING WITH SET ANALYZERS         |
| Book No. 9<br>AUTOMOBILE RADIO AND SERVICING           | Book No. 18<br>POINT-TO-POINT RESISTANCE ANALYSIS   |
| Book No. 10<br>HOME RECORDING AND ALL ABOUT IT         | Book No. 19<br>PRACTICAL RADIO KINKS AND SHORT CUTS |
| Book No. 12<br>PUBLIC ADDRESS INSTALLATION AND SERVICE | Book No. 20<br>THE CATHODE-RAY OSCILLOSCOPE         |
| Book No. 13<br>ABC OF AIR CONDITIONING                 | Book No. 21<br>BREAKING INTO RADIO SERVICING        |
| Book No. 14<br>POCKET RADIO GUIDE                      | Book No. 22<br>NEW RADIO QUESTIONS AND ANSWERS      |

**EACH BOOK IN THIS SERIES—50c**

RADCRAFT PUBLICATIONS, Inc., 99 HUDSON ST. NEW YORK, N. Y.  
Gentlemen: Enclosed find my remittance of \$..... for which send me. POSTPAID, the Manuals or Books indicated below by a cross (x) in the panel.  
( ) Volume 7 @ \$10.00 ( ) 1936 Manual @ \$7.00 ( ) 1935 Manual @ \$7.00  
( ) 1935 Auto-Manual @ \$2.50 ( ) 1934 Manual @ \$3.50 ( ) 1932 Manual @ \$5.00  
( ) Refrigeration Manual (Vol. I) @ \$5.00 ( ) Refrigeration Manual (Vol. 2) @ \$5.00  
( ) Air Conditioning Manual @ \$5.00

**RADIO-CRAFT LIBRARY SERIES @ 50c EACH**  
Circle book numbers wanted: 2 3 6 9 10 12 13 14 15 16 17 18 19 20 21 22  
Name ..... Address .....  
City ..... State .....  
(Send remittance in form of check or money order; register your letter if you send cash or unused U. S. Postage Stamps.) RC-639

Please Say That You Saw It in RADIO-CRAFT

# RADIO-CRAFT

“RADIO'S GREATEST MAGAZINE”

## TELEVISION ANGLES

By the Editor — HUGO GERNSBACK

**B**Y the time this magazine is in your hands, television will have started in earnest. No longer will we say that “television is just around the corner.” April 30th was the day that, concurrently with the New York World's Fair, television actually arrived. Daily broadcasts from NBC's Empire State transmitter are now an accomplished fact. Other sections of the country are getting in line, and if radio history is to be repeated in television, it will not be long before the entire country will have television transmitters—not by the hundreds but by the thousands.

There are many angles of television which puzzle the layman and radio men alike, and for this reason a number of the more important television angles are discussed below.

**SIZE OF IMAGE:** The standard image now is about  $7\frac{1}{2} \times 10$ ". This gives good picture value and enough detail for most of the scenes. Our images will be larger in the future. At the present time television receivers cannot be successfully operated in full daylight or a strong indoor light as the brilliancy of our television tubes is as yet not sufficiently great. In the not too distant future we will have bright enough images to permit viewing them even in bright daylight.

**COLOR TELEVISION:** Curiously enough, laymen particularly, place great stress on television in *natural colors*. People who see their first television receiver invariably ask: “When shall we have television in colors?” In this they are probably motivated by Technicolor films. The answer is that, while perfectly feasible in the movies, television in full colors is still in the future. This is true, of course, for both the transmitter and the receiver, but at the present time engineers spend all their time to give us good television in black and white. Even today motion pictures are not all in colors and it will take many years before every picture film is in colors.

**TELEVISION NETWORKS:** There is another question very frequently asked today: “Are television transmitters to be linked up the same as are present radio networks?” The answer is, “Yes—in time.” This development also will take considerable time to accomplish. We have the means today to link television stations together by means of the *coaxial cable*. Only one such cable is in use now between New York and Philadelphia. It is very expensive to build and must be underground. It would cost several hundred millions of dollars to link up thousands of television transmitters; and while in the end the coaxial link will probably be used, it will take years to lay the necessary lines of pipes to link the stations together. The other means is by radio, that is, linking of television transmitters by radio impulses on a very high frequency (short wavelength). This is feasible because on these ultra-high frequencies there is very little static, and it is conceivable that at the start transmitting stations will be linked in such a manner.

**HOW MANY TRANSMITTERS:** Television transmitters operate on ultra-short waves which means that the *normal* range is only as far as the eye can see. The higher the elevation of the transmitter the farther it will reach. In New York City, for instance, the Empire State transmitter, being over 1,200 ft. from the ground, has a reach of some 50 miles. As most transmitters will be considerably lower than this—unless located on mountains—the average range of a transmitter, thus, is about 25 miles. Therefore to cover the entire country we will require a theoretical

number of 2,500 transmitters to give service to every point in continental U. S. This, however, is only a theoretical figure because it would include lakes, deserts and other very sparsely inhabited parts of the country; instead, a maximum of about 2,000 television transmitters will probably be the eventual total figure for the entire country.

**TELEVISION AND MOTION PICTURES:** This is another problem that seems to worry a great many people—unnecessarily so. Many laymen and even motion-picture people are of the impression that the minute we have television, this will be the death knell of motion pictures. Such a contention is ridiculous. We have had these mental bugaboos for many years.

Years ago the railroad was supposed to put out of business every horse-drawn carriage and wagon. Later the automobile and truck was to put out of business the railroad and horse as well. Nothing like this has happened. Indeed, we probably have as many horse-drawn carriages and wagons today as we ever had, and so far the automobile has not put railroads out of business either. Admittedly, it has put a dent in the railroad business, but even now the railroads are staging a comeback. Neither did the radio put the phonograph out of business; indeed, there are far more phonographs and records being sold now than before the advent of radio. Nor did the motion pictures put the theater out of business either; there are as many theaters now as there were before, and in many localities we have even more of them.

We will find that the motion picture will complement television, and television will in turn help the motion picture. No one in television thinks of putting on complete motion-picture-type spectacles. Even in radio today, stage shows or operas are given in highly condensed versions. Few of them run an hour, many much less. It will be so in television when the average length of any television program will probably run about 15 minutes. The motion picture industry will find it to its advantage to have television show short preview flashes of coming moving pictures, just as you see them in your favorite motion picture houses now. So in your home you will see a few tantalizing shots of a coming motion picture which in its complete form you will have to see at your local film theater; the motion picture industry will give only a few samples to whet your appetite to see the complete show which, you realize, will not be given to you free in your home via television.

**PRICES OF TELEVISION RECEIVERS:** At the present time the range of prices of television receivers is between \$200 and \$400. This means that only the well-to-do can afford television receivers. Television kits have already made their appearance, and you can now “build your own” anywhere from \$50 up; and before the year is over it is certain that the cost to build a television receiver yourself will be considerably lower than this figure. From this it seems certain that for some little time to come we will witness again an intensive build-it-yourself cycle. Radio Servicemen, radio fans and experimenters alike will be in their own again, the same as they were during the 'Twenties period, the heyday of radio construction. I have little doubt that we will have a television boom similar to the radio boom in 1921-'25. At the present time there exists such a boom in England where television has taken rapid strides. We are still at the very beginning of television and there is a great and wonderful future immediately ahead for this new Art.

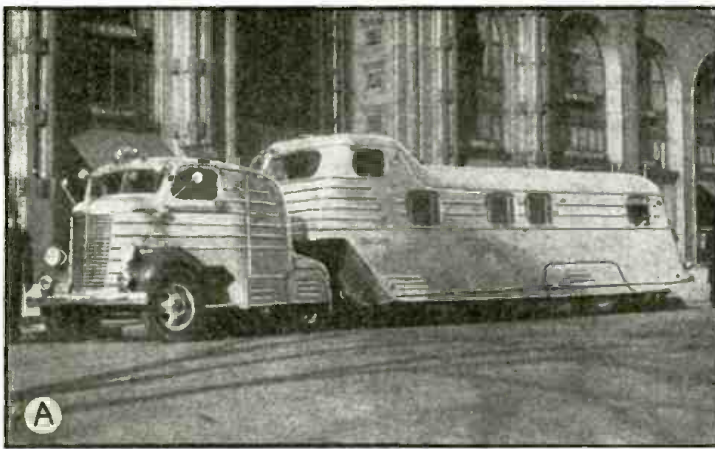

AMATEUR RADIO LUXURY-TRAILER STATION

(A) Housed in a mobile unit (a Chevrolet cab-over-engine truck and ultra-modern Schult trailer) which serves as a traveling office and rolling home, this amateur station is completely self-sufficient. Station output is 1,000 watts. Power supply includes 3 units for the radio system and one for the truck's power, lighting and ignition system. Has tile bathroom, air conditioner, refrigeration, a stove and other conveniences. (C) Myron Zobel, an eastern advertising executive, can if he cares to, talk to Hindustan. (B) The Amplex rotary-beam antenna (for directional transmission), here shown collapsed, extends 8 ft.

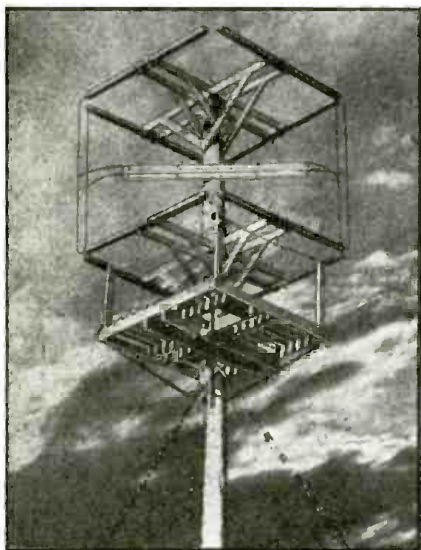

CUBIC TELEVISION ANTENNA FOR W2XB

High in the Helderberg hills is this newest of antennas for General Electric's 10 kilowatt (and, 'tis said, America's highest-power) television station, 12 miles outside of Albany, N. Y.



WIRED MUSIC FOR LONGSHOREMEN!

The Muzak system of sound-over-telephone wires (August 1936 Radio-Craft, pg. 81) last month was introduced at considerable expense by Isbrandtsen-Moller Co., Inc., steamship operators, to dock-men.

# THE RADIO MONTH

## TELEVISION

**D**IRECT comparison of the R.M.A. and Allen B. duMont systems of television will be possible shortly when 2 duMont television stations, one operating on each system, go on the air at Passaic, N. J. An experimental license has been granted for operation on the 42 to 56 mc. band to determine the relative merits of these systems. (These transmissions will be added helps to the boys in the field who are installing and servicing television receivers within the service area of these stations.)

The duMont system, as described in *Radio-Craft* some time ago, in eliminating the need for sweep circuits at the receiving end and therefore concentrating all scanning mechanism at the transmitter offers advantages of far-reaching importance to commercial television.

Farnsworth and duMont applied to the Securities and Exchange Commission, last month, for permission to peddle stocks in their respective television systems—Farnsworth, \$3,600,000 worth and duMont, \$750,000 worth.

Television servicing in England is beginning to reach a fine art. A well-known British radio manufacturer now has a completely-equipped truck with 2 extensible antennas on the roof and operating television receivers inside the van. Equipment in the van includes complete sets of tubes, and all necessary tools and test equipment for installing and servicing television receivers.

We wonder what American company or service organization will be the first to copy this idea.

Over 100,000 television receivers will be sold in America this year, predicted Stanton Griffis of Paramount Pictures, at the 15th annual convention of the

Board of Reviews of Motion Pictures in the Hotel Pennsy last month.

## SOUND

**F**ILENE'S, a progressive department store in Boston, Mass., last month set an example to other department stores throughout the land by installing an extensive sound system.

Three sound "broadcasts", originating from any one of 9 microphone locations (the manager's office, etc.), may be transmitted simultaneously to different parts of the store. These store programs also may be transmitted by a telephone hookup to local stations for regular radio transmission; conversely, radio programs may be picked-up and rebroadcast to all parts of the store.

Arrangements have also been provided by RCA so that executives may address either customers or employes; interphone or 2-way operation is also available!

Muzak, the system of sound-over-telephone lines described some time ago in *Radio-Craft*, is now making its bid for business in the Philadelphia area; which of course means installation and service work for Philly sound men.

A director of Muzak has a monitor line that brings programs on a private wire to his home. A party at the director's home was enlivened last month when a gossip program, ribbing party attendees, that had been previously prepared by one of the guests came over the high-fidelity sound system!

A Muzak installation made last month at Pier 30 (Brooklyn, N. Y.), for Isbrandtsen-Moller Co., Inc., made "all the stevedores, loaders, checkers and members of the pier office happy." What sound man will be No. 1 to "sell" other "cargadores" the idea of using an automatic phonograph for similar purposes?





PUBLIC ADDRESS AT \$2,000,000 "MEADOWBROOK VILLAGE" DEVELOPMENT

(Photos—Rudy Arnold Photos)

Due to the extremely large area—26 acres!—in which work on their Plainfield, N. J., garden apartment development is going on, the contractors last month hit upon the idea of communicating across the development by means of 5 loudspeakers and amplifiers and 5 telephone sets, all interconnected and leading to the office. When finished, Meadowbrook Village—a "city" within a city—will consist of 50 apartment buildings containing 1,150 rooms—housing for 400 families; a public school, swimming pool, stores, and its own gas, water and electricity system. The amplifier, Mr. Sound Man, is a 20-W. Operadio job.

## IN REVIEW

### FREQUENCY MODULATION

MAJOR EDWIN H. ARMSTRONG, Professor of Electrical Engineering at Columbia University, held listeners spellbound as he described his system of frequency-modulated transmission and put it through its paces at Columbia's Pupin Hall (N.Y.C.), last month, at a meeting of the Radio Club of America. Messrs. Weir, Fyler and Worcester descended from the Schenectady and Bridgeport offices of the General Electric Company to deliver companion articles on "F.M."

The demonstrations, which *Radio-Craft* witnessed, included relay transmissions so perfect it was impossible to determine, when a switch was manipulated, whether the pick-up was direct or relayed. The rippling sounds of a "liquid" being poured ("Radio has its limitations," the major "dryly" commented.) demonstrated the remarkable fidelity range of the transmission, which extended from below 30 cycles to above 18,000 cycles; "A frequency range up to 18,000 cycles has been found desirable in some music transmissions," Major

Armstrong said. Total harmonic distortion, up to 20,000 cycles, "is less than 1%."

The experimental transmissions were made from station W2XAM at Alpine, N. J., on about 42.8 megacycles and 20 kw., and station 2AG in Yonkers on about 110 megacycles (about 2.6 meters) and 1 kw.

The amazing carrying power of frequency-modulated transmissions was demonstrated by reducing the output energy from station 2AG to about 1 watt (by cutting-off final-stage power so that radiation was then only the "leakage" across this tube to the antenna) with only a slightly perceptible increase in the background-noise level. It was further demonstrated that seemingly the only source of background noise at maximum receiver sensitivity and minimum signal input was the shot effect and thermal agitation in the 1st R.F. stage of the receiver.

Frequency-modulation transmission is now ahead of terminal equipment, stated Major Armstrong, who says that what is now wanted are high-level microphones.

A furore was created when the ingenuity of a Columbia U. man in the form of a 6-tube frequency-modulation receiver was demonstrated to have ample output to adequately fill the entire auditorium with sound from the special wide-frequency-range G.E. column loud-

(Continued on page 748)

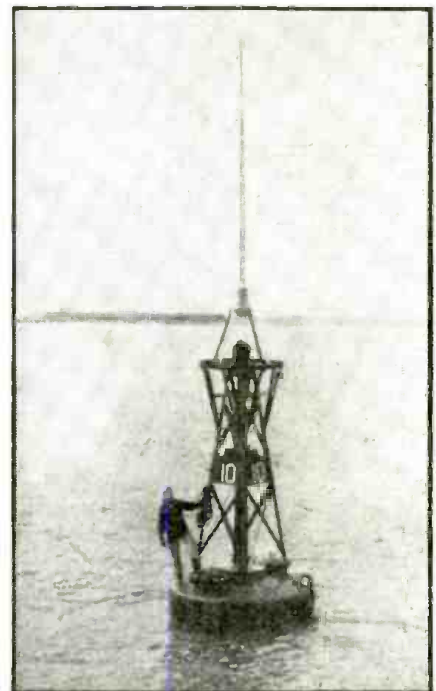

THE RADIOBEACON SERVICEMAN

The seagoing radio Servicemen who attend the new buoys which radiate code signals on frequencies recently assigned to the Lighthouse Service, because lives depend upon the uninterrupted performance of these buoys, must be experts.



#### HOSPITAL TELEVISION

At right, you see → how an A.T.C. electron television camera (above table) televised a surgical operation at Israel Zion Hospital, Brooklyn (N.Y.), last month, by cable to nearby student observers.

← In the auditorium, 500 ft. away (see photo, left), 150 medical students and other observers watched 6 remote "Kinets" (individual cathode-ray television receiving tubes). Overhead coaxial cables connect the Kinets and the camera. The customary lighting is adequate for television.

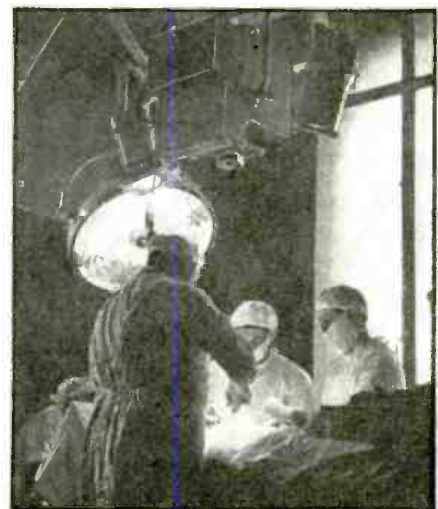

# "FOR DISPLAY

. . . . *But a*

*Servicemen will now be able to cash-in on more, on the 1,216-acre New York World's \$150,000,000 entertainment center. "How radio set in a miniature World's Fair sphere"—illuminated and seemingly sup-novel money-maker for the radio man*

JOSEPH H. KRAUS

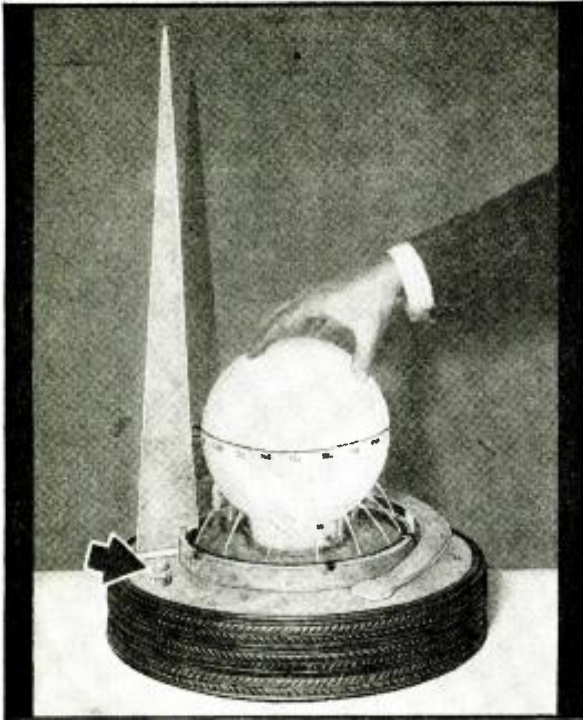

"THE RADIO SET OF TOMORROW" . . . maybe. Anyway it makes a swell display for hotel and theatre lobbies, bars, restaurants, etc. Turning the perisphere tunes the set, while the music issues from underneath. Streams of water playing on the perisphere and colored "revolving clouds" inside the latter add to the display.

**T**HE Radio Set of Tomorrow mounted within the base of the Theme exemplifying the "World of Tomorrow" is the subject of this article. Not only is the set and its "cabinet" modern, but in addition, it has not only its own *fountain* and *mirror pool* operated by a self-contained unit, but also an *illuminated sphere!* Unlike the usual radio set, which serves for little purpose when not in operation, this set may be used as a disseminator of perfumes, a lamp, or as an ornament. Even when the radio set is not in operation, the pleasing sound of water striking the glass and dropping into the pool is soothing to the nerves.

*Servicemen should find it profitable to build these "theme sets" for use in bars, hotel lobbies, department stores, and wherever a "talking fountain" of this sort may be suggested as a timely novelty and great attention-getter.*

(Smaller "themes" are available and may be used in other arrangements of theme-and-set than as here described.)

This Theme Set includes a Receiver Chassis built by Mr. McEntee, and a Fountain built by Mr. Kraus. The latter unit, although not essential, was installed at the suggestion of Mr. Kraus as a means of adding to this "utilitarian model" the realism and dramatic appeal presented by the fountains in the original Theme.

## THE RECEIVER CHASSIS

The Receiver Chassis of this novel set uses what may be called "the tubes of tomorrow"—the new *loctal* (lock-base) type. These tubes are all single-ended; and the R.F. types have built-in shields so that no external shields are required. Each socket has a spring arrangement which holds the tube firmly in place once it is properly inserted. The center clip also acts as a shield.

Five of the new tubes are used in a superheterodyne circuit, and iron-core transformers throughout assure a very sensitive and selective set.

Construction of the set is a bit out of the ordinary since it must be quite flat—the maximum depth being about  $2\frac{3}{4}$  ins. For the same reason, the speaker specified in the parts list was chosen, since most speakers are too deep. Coil L2 is used minus its shield can.

The entire chassis may be made from a single piece of aluminum  $7 \times 10 \times 1/16$ -in. thick. It is easier to cut socket holes before bending. In the set shown, the sockets were placed inside the chassis. This means that  $1/16$ -in. of aluminum will be between the tube and socket. Some sockets will allow the tubes to seat properly under these conditions and some will not. Test *all* the sockets carefully before use as it may be necessary to cut the holes large enough for the whole tube base to pass through. There are no half-measures with these sockets; either they click onto the tubes properly, or the tubes will not stay in place at all.

## WIRING

Wiring is done without the variable condenser in place. The grid and plate leads of V2 *must* be well separated from each other, and from other leads, to prevent circuit oscillation. Beyond this, most of the wiring may be made point-to-point.

In the original receiver a dual 8 mf. electrolytic was wired-

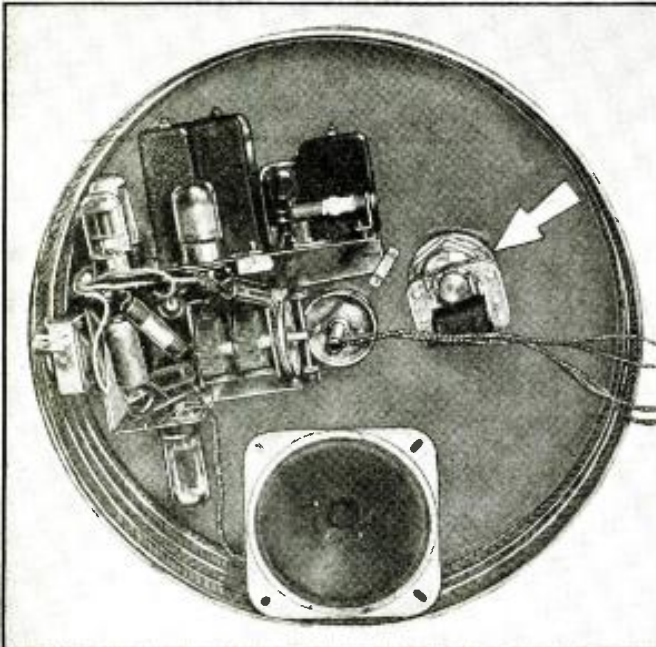

The entire "works" is located in the base of the World's Fair Theme. The arrow points to the compact fountain pump. Note the peculiar construction of the radio chassis.

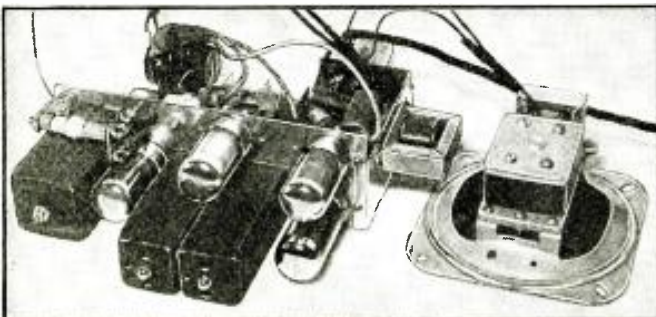

Looks haywire but plays beautifully! Volume control shown in the background mounts on the base, with the shaft protruding to the top-side. The new single-ended loctal-type small-space tubes are employed.

# PURPOSES ONLY!" . . . .

## Good Money-Maker for Servicemen

the nation-wide attention which will be focused for the next 6 months, and Fair 1939. This Summer, more than 50,000,000 people will visit this can the radio man tie-in his work with this enterprise?"—The answer: "A 'theme'" (an original conception by R. D. Washburne), in which the "Periscope on a fountain—becomes the set's tuning knob! Just how this new and can be made for the custom trade is the purpose of this article.

and HOWARD G. McENTEE

in first. Later it was found that an additional 20 mf., 200 V. unit on the output of the filter would cut out the last bit of hum.

The heater cord series resistor may be anywhere between 1,800 and 220 ohms. As these cords are designed to carry 300 ma. they barely get warm with 160 ma. as required by the new low-drain loctal tubes.

The R.F. tuning condenser, the padding condenser, and the R.F. primary are connected directly to the chassis while all other "grounds" are made to "B-" and insulated from chassis. Two 0.1-mf. condensers complete the R.F. circuit. Since the shield bases of the tubes are exposed, they must also be connected to chassis, but the internal shield of V2 goes to "B-". A slight instability at the extreme low-frequency end of the tuning range was cured by addition of a second 0.1-mf. condenser to the one already in place. In some cases only one may be needed, so they are shown separately.

It will be seen that no bypass is used on the cathode resistor of V4. The beam-type of tube, due to its peculiar characteristics, does not require this condenser.

(For details regarding the components of this set, see "LIST OF PARTS—Theme Set," at the end of this article.)

### THE FOUNTAIN

The Fountain unit of this set is of very simple construction (and is thoroughly covered by patents). The motor is a small 20-watt Barber-Colman induction motor, operable *only* on A.C.

The stator of the motor is press-fitted on the outside of a brass well which receives the rotor. To the shaft of the motor is attached the small impeller blade which converts the article into a pump. Thus, it will be seen that the rotor of the motor runs in the water all of the time. By such a construction it is impossible for the fountain to leak, inasmuch as

all of the moving parts are under water and there are no pipe connections to be made.

A hole is drilled through the Catalan base and the well is pushed through this opening; cork gaskets at the top and bottom make a watertight fitting when a lock-nut is tightened in place. The feed pipe for the fountain spray is a ¼-in. inside diameter copper tubing, coiled just inside the edge of the "Mirror Pool." One end of this pipe is soldered into the pump and the free end is fitted with a ¼-in. screw threaded into the tube; if dirt accumulates in the pipe, it can be washed out by opening the far end of the pipe. A small, wire gauze filter is recommended to keep out any of the larger particles of dirt and prevent them from clogging the spray holes.

In this construction the spray holes were drilled with a No. 48 drill at such an angle that the water sprays strike the globe low, otherwise there might be considerable splashing. However, this is a matter of preference with the builder and he could substitute streams of water shooting straight up. While this would enhance the fountain effect, it would not be in keeping with the original Theme.

### PERISPHERE "TUNING KNOB"

The "Perisphere" is a glass globe inverted on a Catalan base. This base is grooved to accommodate the sphere and rises higher within the globe than outside; the purpose, of course, is to prevent any water from filtering inside and wetting the lamp socket and its connection. The socket itself is mounted on a standard section of pipe, bolted fast to this Catalan disc.

This pipe passes through the base and has attached to it a small 2-in. drum connected by a cord to a second drum of similar size attached to the shaft of the condenser. Inasmuch

(Continued on page 765)

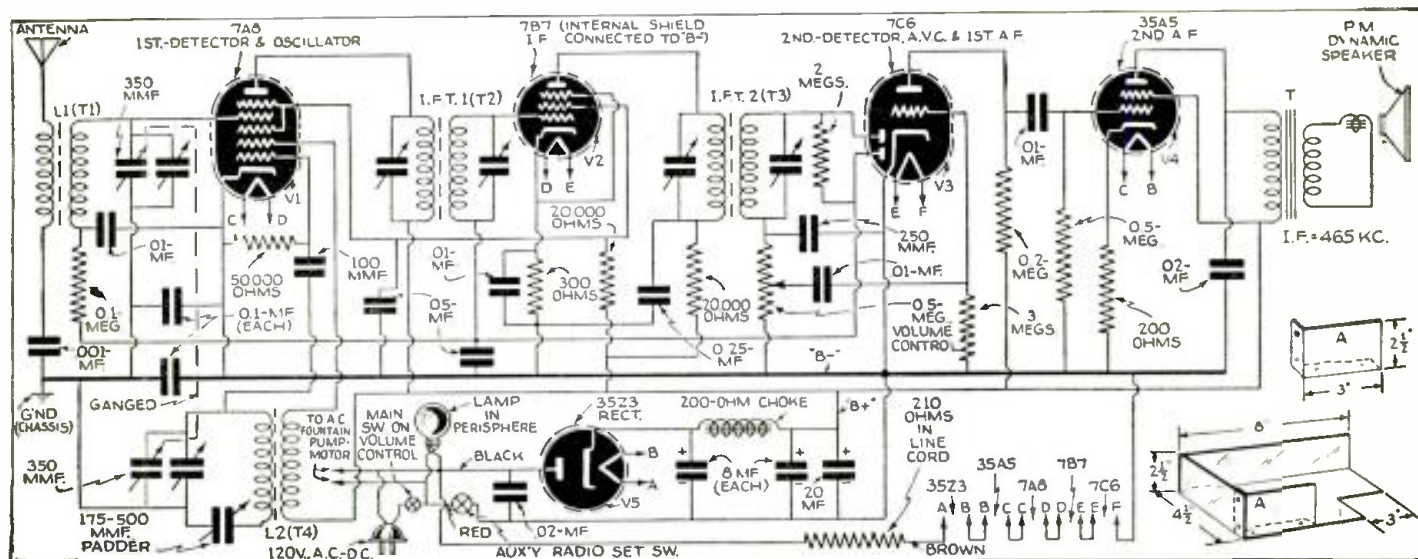

Diagram of the 5-tube A.C.-D.C. chassis used in the World's Fair Theme display set. All the coils are high-gain iron-core type; tubes are loctals. Arrow in photo (upper-left, pg. 712) points to main switch shown above; auxiliary, Radio Set switch is in back of trylon and hence does not show in photo.

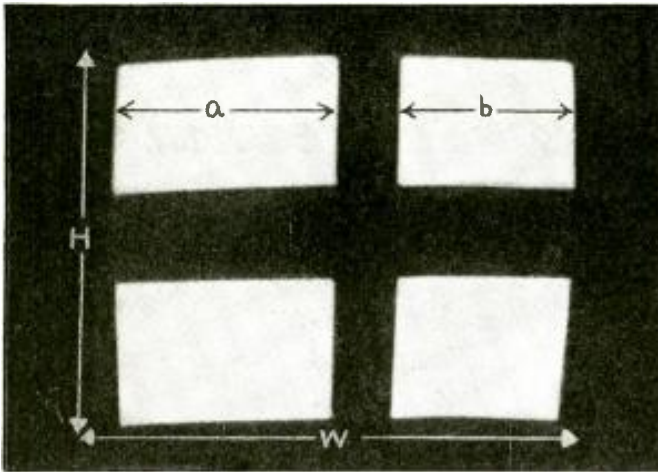

Fig. 1. Appearance of cruciform pattern due to non-linear line-sweep voltage.

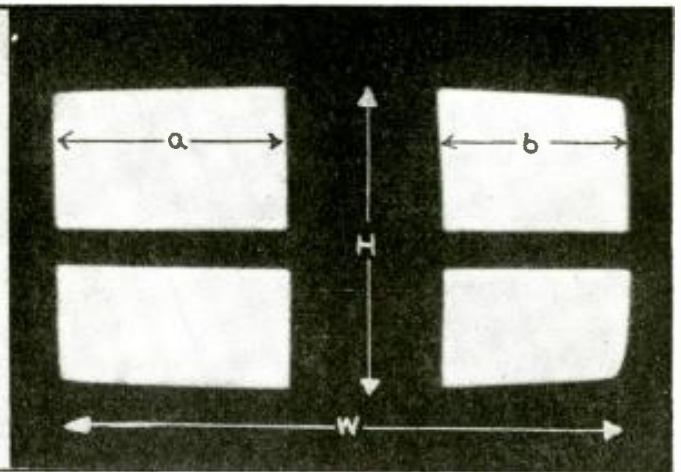

Fig. 3. Another effect of non-linear line-sweep voltage producing incorrect aspect ratio.

# SERVICING TELEVISION

*Unlike previously published articles of a theoretical nature on the servicing of television and Short-Wave World (London, England), is a practical analysis illus-*

It is a fact that any person whose knowledge of television receiver design is at all complete can, in the majority of cases, by examining a defective image, at once state the probable cause and the necessary cure for the defect, or briefly, he can quickly place the apparatus in good order.

It is the writer's opinion that for the less expert person it is only necessary to show him pictures of faulty images, mutually agree which of these is truly representative of the fault experienced, then to detail the circuit changes necessary to effect a cure, and he is almost as well equipped as the more experienced worker to correct television image faults. The photographs to be reproduced in this series of articles were therefore obtained for this purpose.

## S. WEST

It should perhaps be added that such photographs are not by any means easy to make. In the first place they were all secured in the writer's laboratory about 100 miles from the transmitter, which fact alone rendered the task intricate. Secondly, it is one of the anomalies of such apparatus that a specific fault that can occur entirely unintentionally, and when it is not wanted, often is difficult to invoke to order; moreover, certain minor faults cannot be photographed at all. *Despite these difficulties, it is believed the complete series will be representative.*

(In this series of articles, the word *image* is used to denote the evanescent pattern obtained on the end of the cathode-ray tube; the word *picture* is used in connection with the actual and permanent picture or photograph obtained by a camera.—Editor)

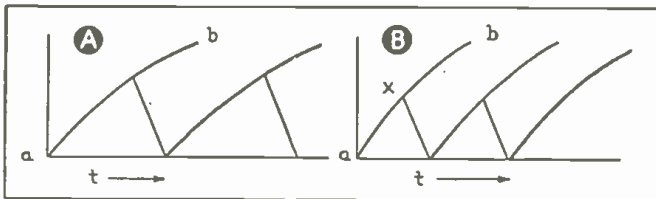

Fig. 2. (A) Incorrect and (B) correct time-base waveforms.

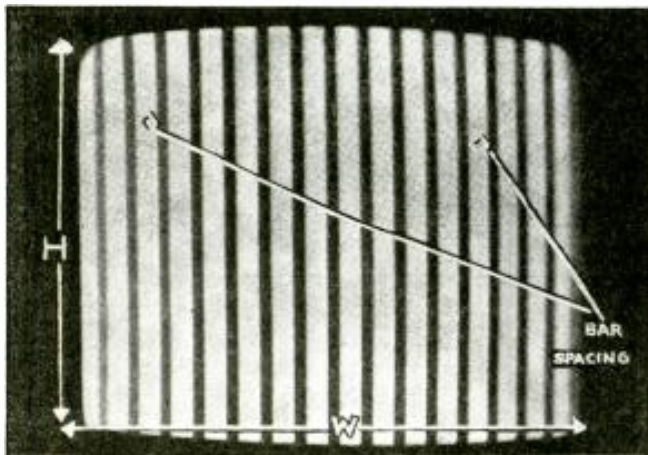

Fig. 7. Test pattern for linearity of line time base.

## RASTER FAULTS

If we adopt a logical order of faults we find that we are firstly concerned with the plain raster (image-free or unmodulated light area), for obviously we must have this right before tackling the remedy of actual image-reproduction defects.

The most commonly experienced fault in a raster is that due to a non-linear scan in either the vertical or horizontal direction or both concurrently.

Figures 1, 3 and 5 depict the familiar cruciform pattern radiated by the transmitter prior to the commencement of the program. Let us consider the image of Fig. 1. It is seen that the distance  $a$  is greater than  $b$ . This is due to the production of a non-linear sweep voltage by the line time base. The desired waveform for the oscillation is shown in Fig. 2B. The waveform responsible for the non-linearity is likely to have a form resembling that shown in Fig. 2A.

Now it is important fully to appreciate the following.

The sawtooth oscillation is produced by the charge, through a resistance, and the discharge, through an electronic device (i.e., a gas relay), of a condenser. The charge current is of the form indicated by the curve  $ab$  in Figs. 2A and 2B. This curve has an exponential shape but it is seen that if we arrange the discharge to take place at  $x$ , Fig. 2B, that this portion of the curve is reasonably linear. Consequently for a linear scan, we must arrange for the discharge cycle to occur at this point or earlier. It should be mentioned parenthetically there is an alternative, namely, to employ a constant-current device (pentode or diode tube) through which the condenser is charged. It is not proposed to deal with such arrangements, however, for they render the

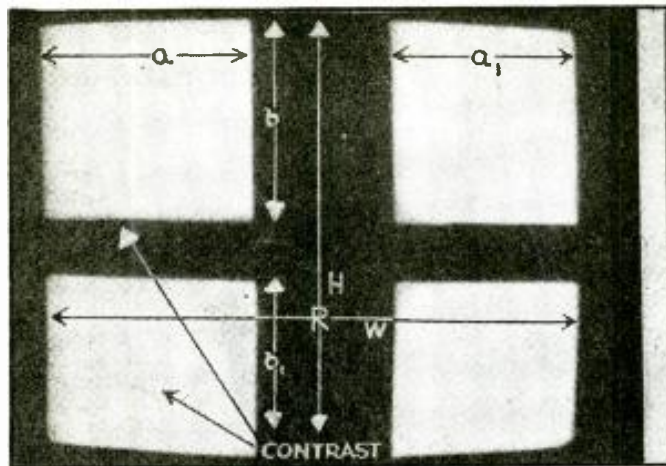

Fig. 5. Cruciform pattern with slight non-linearity in both line and frame sweep voltages.

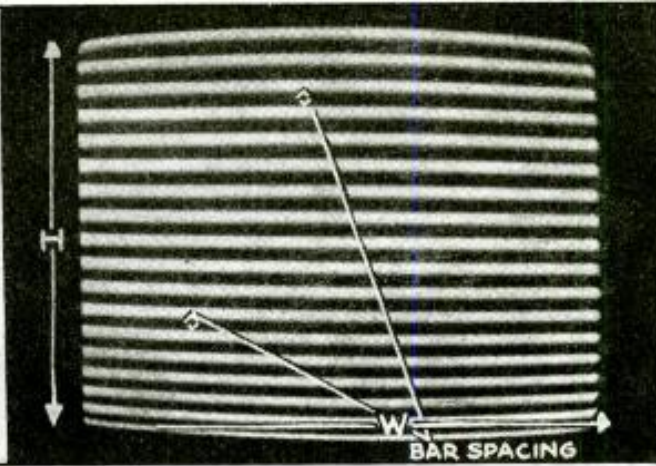

Fig. 6. Test pattern for linearity of frame time base.

# RECEIVER FAULTS

*vision receivers this series of articles, which we reprint by special permission of treated with photographs of images which depict the actual faults being discussed.*

apparatus more complex. To achieve this end, that is to insure linearity of charge, the time base high-voltage must be considerable (usually over 1,200 volts for a 12-in. tube), for of course we only employ a very small part of the complete charge curve.

Assuming the high-voltage is adequate, then the point  $x$ , in the case of a time base employing gas relays, is chosen by the value of bias for this tube and will have adequate amplitude for our needs. Precisely similar procedure is involved for other forms of time base, the main point being that the condenser must discharge at  $x$  or earlier.

## TIME BASE SPEED

This brings us to another consideration, namely, the nearer to  $a$  that our discharge takes place, the higher will be the frequency of the sawtooth oscillations. This must be so for the discharge takes place earlier on the curve  $ab$ , which is plotted against Time. So that, if in our efforts to insure linearity, we have caused our time base to operate at an incorrect frequency we must remedy the matter.

This is simply achieved. It is assumed that the capacity of the charge condenser has the conventional value for the position in which it is used and it only requires to increase the value of the charge resistance to reduce the frequency of the oscillations.

Condensing the above information for a specific case, that of a time base employing a gas-relay sawtooth oscillation generator, if non-linearity of scan exists, reduce the bias of the relay by reducing in value the cathode resistance, or make similar changes to whatever biasing arrangement is employed, then, restore to the correct operating fre-

## PART I

quency by increasing the value of the charge resistance.

### IMAGE RATIO

In Fig. 3 we have the cruciform pattern once more. Note that the line sweep is again non-linear but a more unpleasant effect obtrudes, namely, the *aspect ratio* (the ratio of height to width), is entirely incorrect due to disproportion.

The correct aspect ratio for images transmitted from Alexandra Palace is 5:4. From Fig. 4 the correct image dimensions can be obtained. The diameter of the tube is given by the diagonal  $D$ . Knowing this the correct height and width is easily secured.

For example, the  $W/H$  ratio for a tube having a 10-in. diameter screen is seen to be  $7\frac{3}{4}$  ins. by  $6\frac{3}{4}$  ins. In practice it is permissible to exceed these dimensions but the proportions must be retained.

Now within the limitations imposed by the requirements for linearity of scan, we can adjust this aspect ratio with the bias on the discharge tube and this is the correct course to adopt.

It is necessary to interpose a word here concerning time bases that employ a balanced output system (electrostatic deflection). While the image shape can be controlled to a certain extent by varying the input to the second amplifying stage, such procedure is unwise. This point will be dealt with later in some detail but for the time being it can be assumed that with the paraphase tube removed, the image should be approximately half the width or height, as the case may be. It is seen then that the correct aspect ratio is mainly determined, once the amplifying stages are designed, by the amplitude of the oscillation generated by the gas relay.

Figure 5 is again of the cruciform

pattern. For all practical purposes the aspect ratio and linearity can be deemed satisfactory. There is shown slight non-linearity in both the frame and line bases but for various reasons it is difficult entirely to remove this defect.

An examination of this photograph reveals the distance  $a$  to be slightly greater than  $a_1$  (slight non-linearity in the line base). Similarly  $b$  is greater than  $b_1$  (slight non-linearity in the frame base). The aspect ratio  $R$ , that is  $H/W$ , is substantially correct. Note also the good contrast, namely, black and white and not an intermediate contrast.

Figures 6 and 7 show the effect of applying an oscillatory voltage to either the C.-R. tube or the V.F. tube grid. If no oscillator is available it is worth while setting up temporary apparatus for this test.

A frequency of approximately 400-1,000 cycles-per-second is entirely satisfactory for the vertical test and approximately 150-200 kilocycles-per-second for the horizontal. A simple dynatron

*(Continued on page 746)*

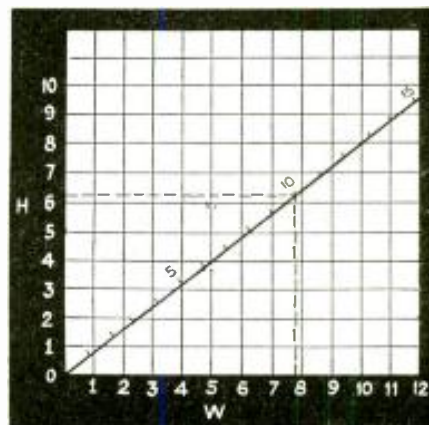
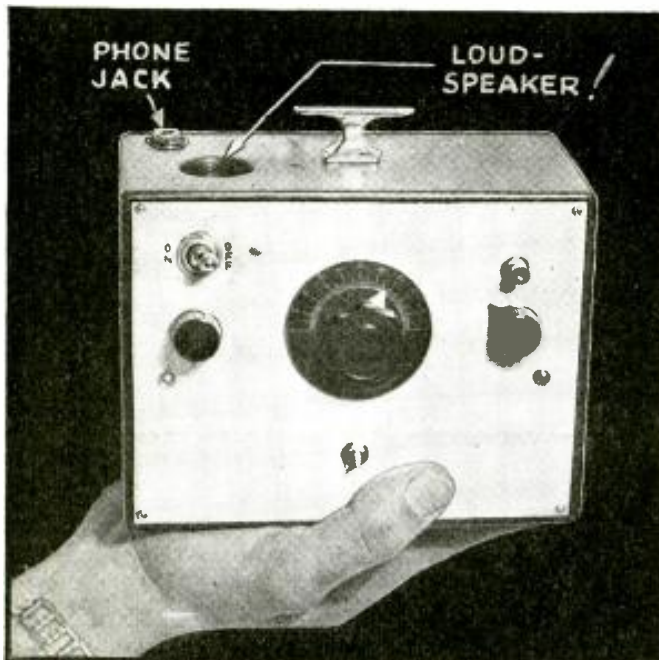

Fig. 4. Height-width image dimensions.

# How to Build 5-TUBE BATTERY-PORTABLE

RADIO-CRAFT presents the World's Smallest Battery-Power 5-Tube  
Mr. R. D. Washburne, this tiny receiver hangs up a new record

HOWARD



The complete set, including "A" and "B" batteries, weighs only 2¾ lbs., yet it is small enough to fit into the palm of a hand! It is a full-fledged 5-tube superhet. using the tiny English Hyvac tubes and affords fair loudspeaker reception. THE BATTERIES ARE INSIDE THE CASE!

THE writer has always had a hankering to see how small a complete superhet. with power supply and speaker could be built and still get good operating results. This problem, of course, hinges upon what we might consider "good operating results." Opinions differ on this, naturally, but at any rate the little receiver presented here is about as small as can be made without using many special or custom-made parts.

Five of the popular English midget tubes are used. Unfortunately these tubes are not obtainable in the pentagrid-converter type. A screen-grid tube can be used as a combined oscillator and 1st-detector, as was done in the days

before the 1A6 was made, but this calls for a "composite" plate coil of rather large size. Consequently it was decided to use separate tubes for these functions and employ the smallest possible transformers.

The other 3 tubes are used as conventional I.F. amplifier, screen-grid detector and pentode output tubes, respectively.

The tubes are a new development, using 1.5-V. filaments and give somewhat higher gain than the former 2-V. types, although the latter may be used with no changes other than the different filament voltage.

## CIRCUIT DETAILS

A great deal of "fussing" was done on the values used for V1 and V5 since poor operation of these tubes cannot be made up in later stages. The values shown are somewhat unusual but gave best results with the battery supply shown.

Screen-grid injection was chosen as offering the least complication, and it works out very nicely. There is no interaction between oscillator and detector controls and the sensitivity seems quite good.

Due to space considerations and also to the fact that a tiny 2-gang variable of high capacity is not available, separate tuning controls are provided for V1 and V5. The oscillator, of course, is the sharp-tuning one, the 1st-detector condenser being merely tracked along to get best volume. No trouble with double-spot tuning should be had, since a fixed padding condenser in the oscillator circuit brings the two condensers to about the same degree of rotation throughout the band.

A portable set is used with all types and sizes of antennas and the use of separate controls for oscillator and 1st-detector allows the antenna circuit to be brought to resonance no matter what size of antenna is used. This eliminates the need of a separate trimmer condenser in the antenna circuit and thus tends for greater compactness.

A single stage of I.F. with the smallest iron-core transformers made is incorporated with a screen-grid tube, V2. A bias of a few volts is supplied to this tube by running the grid-return to a 0.5-ohm resistor between "B-" and ground. The transformer may be connected to "A-" if desired, thus eliminating the 500-ohm resistor, but strong oscillation will be had in V2 if the volume control is advanced beyond about 10 V. As shown in the diagram the I.F. stage is regenerative but does not break into oscillation.

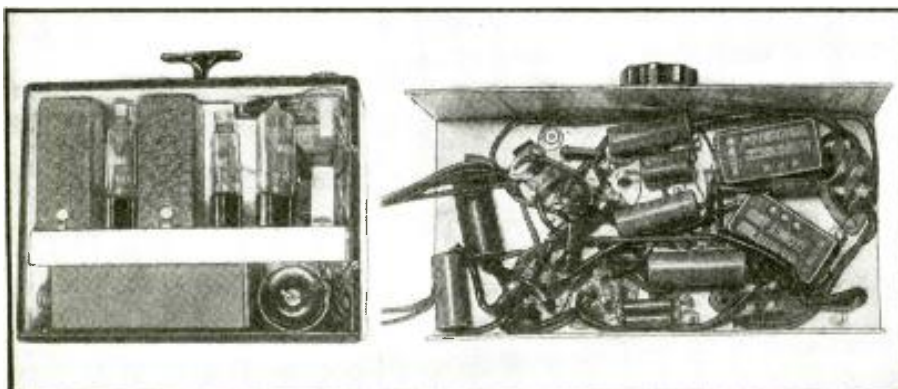

(Left) Rear view of the tiny superhet, showing how compactly the chassis and the batteries fit inside the case. (Right) View looking on the underside of the chassis showing placement of components.

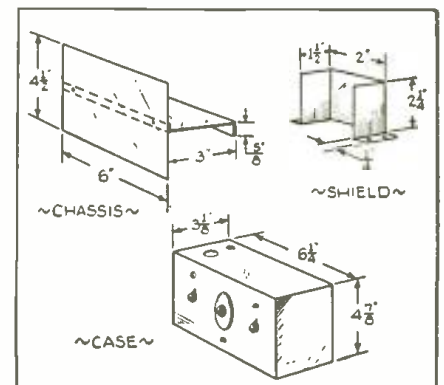

Complete dimensions of the chassis, oscillator shield and the outer wooden case.

# a Tiny 2 $\frac{3}{4}$ -Pound BROADCAST SUPERHET.

Superheterodyne! Built by Mr. McEntee in collaboration with  
in lightness and compactness, at which set builders may aim.

## MCENTEE

Note that the plate lead of each type SG tube terminates at the cap. Therefore, it is necessary to change the leads in T3 and T4 so that the plate caps may be properly connected.

The gridleak 2nd-detector and pentode audio stage are quite conventional. The output circuit of V4 is a bit unusual, however, in that a 3-to-1 A.F. transformer is used as an output coupling unit. The load impedance of this tube is rather high so the primary is a fair match for V4.

The main reason for the use of T5 is to keep D.C. out of the crystal "loud-speaker." When all parts had been fitted into the case which was available, it was found that there was practically no room left for a speaker. The only thing that could be squeezed in was a wafer-thin crystal headphone. These units cannot be used with D.C.; and resistance-condenser coupling would have seriously cut down the already meager plate voltage. A tiny, high-permeability-core A.F. transformer solved the problem, and its secondary is a reasonable match for the crystal "speaker."

A jack allows the use of headphones or a large-size speaker, the former naturally being essential when DX is sought.

The "B" supply was greatly limited in size, so the smallest standard "B" battery is used. It has a fair life since the total plate current is only about 3.5 ma. The "A" supply is a single large flashlight cell. This does not have much life since filament current is about 350 ma. However, these cells are universally obtainable and a clip arrangement can be rigged so that new cells may simply be slid in place.

As all dimensions are shown, no construction data is needed. The case

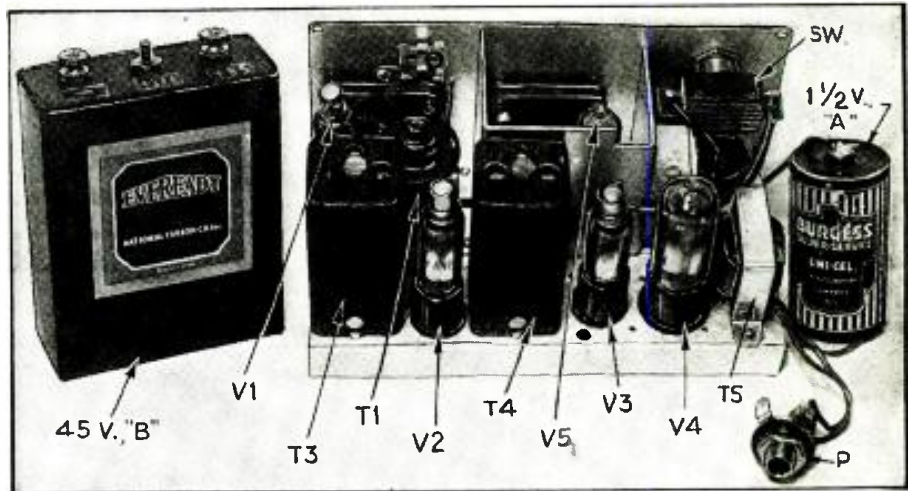

Compare the size of the chassis with that of the flashlight cell and you have some idea of its small size and compactness. It works well with 45 V. as the plate supply. A second 45 V. "B" battery may be employed to advantage if room can be found for it.

shown happened to be on hand, but one could easily be made up from pressed wood, or cigarbox wood to the size detailed. A few coats of paint and a handle complete the unit.

The set shown here, although giving surprising volume and sensitivity, of course, is somewhat in the novelty class due principally to the speaker and power supply. However, if built-up in a case large enough to hold a 3-in. P.M. dynamic speaker, two 45-V. "B" units of the next larger size and a large 1 $\frac{1}{2}$ -V. "A" cell, a really practical unit will result. If higher plate voltage is used, more care will be required in biasing, to keep plate current down. The same system of bias used for V2 will be satisfactory, but V1 and V2 should have from 3- to 4 $\frac{1}{2}$ -V. while V4 needs

from 4 to 6 V. Tubes V3 and V5 are then cared-for by gridleak bias as used in the present set-up.

### LIST OF PARTS

- One Brush Development Co. crystal headphone (for loudspeaker) type B;
- One Amplifier Company of America midget 3-to-1 A.F. transformer, T5;
- One National Carbon Co., Inc., Eveready midget battery, No. 733, 45 V.;
- One National Carbon Co., Inc., Eveready large flashlight cell;
- One International Resistance Co. resistor, 2 megs.,  $\frac{1}{2}$ -W.;
- One International Resistance Co. resistor, 50,000 ohms,  $\frac{1}{2}$ -W.;
- One International Resistance Co. resistor, 10,000 ohms,  $\frac{1}{2}$ -W.;

(Continued on page 747)

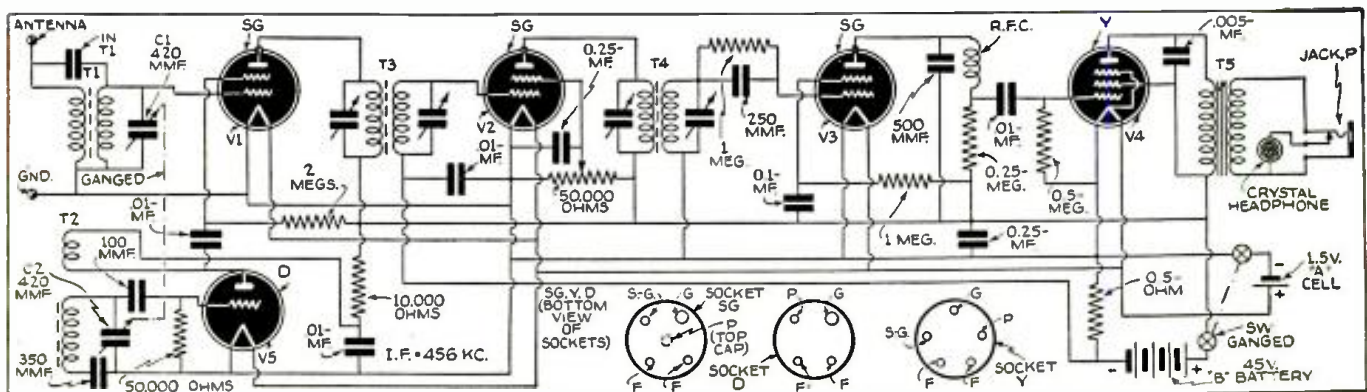

Complete schematic diagram of 5-tube ultra-midget superhet. receiver. Note that the socket connections for the tubes are entirely different from the American system. The plate connection is attached to what is ordinarily the "control-grid" cap on top. The English tube-type numbers are shown.



Fig. G. RADIO IN EVERY ROOM! A neat, unobtrusive installation which enhances rather than detracts from the appearance of the room. This particular remote station is in the master bedroom. Set low in the wall, it is convenient to tune while abed; and, the speaker at ear-level (when reclining) makes for listening comfort.

The RADIO-CRAFT plan for a Radio Home with reception in every room, opens up for the industry a vast new market which will benefit the consumer, the radio dealer, jobber and manufacturer, and the radio Serviceman.

PART IV (CONCLUSION)

N. H. LESSEM

THESE have been many comments, both pro and con, concerning the idea embodied in the "Radio Home". The dissidents, while not objecting to the logic of built-in radio, disagree as to its form. Their main argument is that only one program may be received at a given time—thereby reviving the old family feuds (concerning program selection) which a multiplicity of midget sets in the home seems to have satisfactorily solved. In other words they seem to feel that a built-in radio system should at least be the equivalent of a radio set in each room—a multiple-channel arrangement.

Whether these people are right or wrong is a matter of no great import but this difference of ideas serves the useful purpose of showing that there exist two schools of thought

concerning built-in radio:—those preferring a single-channel system with its single-master receiver (low maintenance cost) and those favoring a multiple-channel system with its corresponding multiple-master receivers (and comparatively high maintenance cost). It is a matter of purely personal preference.

The author can go into long discourses on the strong and weak points of both systems. However, in order to keep the peace within its family of readers *Radio-Craft*, in this installment will first complete the description of the "Radio Home"—a single-channel system—and then in a forthcoming issue describe a multiple-channel system.

We return therefore to the "windup" of our "Radio Home" installation. Yet to be accomplished is the wiring of the

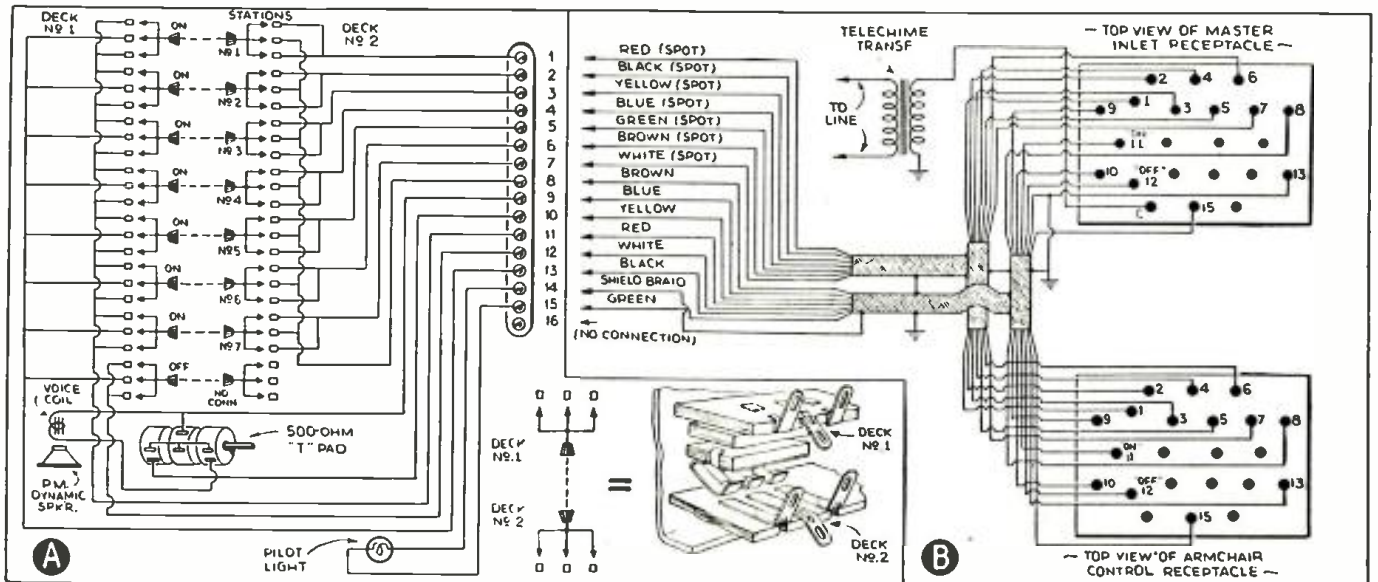

Fig. 6. (A) Diagram for wiring all the components mounted on the speaker brackets. (B) Diagram for wiring master inlet and remote control receptacles, and connecting the wall cables to the terminal strips on the speaker brackets. The wiring for all speaker brackets and receptacles are identical, all cables being wired in parallel.



remote speakers, "T" pads, pushbutton switches; connecting the wall cables to the equipment on the speaker brackets; and, giving the details for the construction and wiring of the armchair control units.

### WIRING THE REMOTE WALL STATIONS

Mount the speakers, "T" pads, pushbutton switches and pilot lights on their respective speaker brackets as shown in Fig. I, and wire them in accordance with the diagram in Fig. 6A. Square-off all wiring so that it may be laced into a neat, commercial-appearing cable. Neat, conscientious work at this point has tremendous eye and sales appeal when showing and demonstrating the system to prospective customers. Notice that all wires terminate on a 16-lug terminal strip (two American Hardware Co. 8-lug strips are used); wire, and check, all remote units before attaching them to their respective wall receptacles. As explained in preceding articles and as shown in Fig. I, these speaker brackets mount to their receptacles by means of two hinges in order to facilitate future servicing.

Now let us turn our attention to the wiring in the walls which terminate at each speaker bracket and at the master-inlet and armchair-control receptacles. The method for running these wires in the walls was completely described in Part II of this series of articles. Two 7-wire shielded cables, you will remember, are used; and since the wires in these cables are identically color-coded it is necessary that the ends of all the wires in one of these cables be spotted with ink (or paint) in order to establish a definite color code. Make absolutely certain that the wires so painted are all from the same cable. A continuity test is the best method for tracing them through. Our working color-code then as finally established (see Fig. 6) is as follows:

- |                       |                    |
|-----------------------|--------------------|
| (1) Red with spot;    | (9) Blue;          |
| (2) Black with spot;  | (10) Yellow;       |
| (3) Yellow with spot; | (11) Red;          |
| (4) Blue with spot;   | (12) White;        |
| (5) Green with spot;  | (13) Black;        |
| (6) Brown with spot;  | (14) Shield braid; |
| (7) White with spot;  | (15) Green.        |
| (8) Brown;            |                    |

This done, it is now merely necessary to attach the ends of these wires to their respective screw posts on the terminal strip on each speaker bracket as shown in Fig. 6. The master inlet and the armchair control receptacles are identically wired as shown in Fig. 6B. These receptacles are really 22-contact "jacks" and are a bit difficult to solder inasmuch as the contacts are closely spaced. Considerable caution therefore should be exercised during this operation. Make certain that the shield braids of all the cables are bonded and soldered together and that a lead therefrom is brought to the proper contact on the receptacles.

The wiring of the entire system (with the exception of the armchair control unit which may be considered as optional and not a necessary part of the system) is now complete; and if all connections have been properly made and the diagrams carefully followed the system should be operative upon plugging-in the master receiver. This "plugging" operation consists of inserting the 22-contact plug on the receiver (see Part III of this series of installations), attaching an aerial and ground to the set, and plugging the master power cord into the electric outlet. The master receiver as you will note can be disconnected from the built-in radio system quite conveniently.

(Continued on page 755)

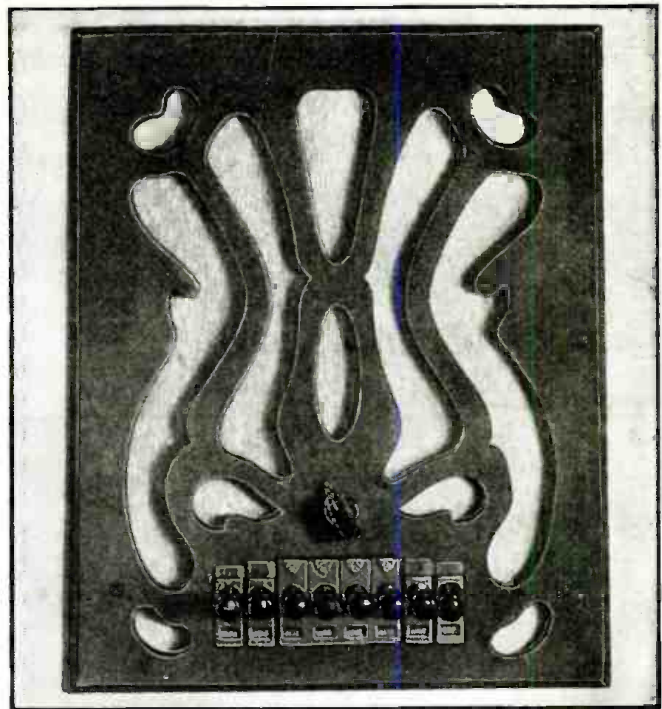

Fig. H. A close-up of the decorative speaker grille mounted in the dinette. Note that the pushbuttons are inverted with respect to those shown in Fig. G on the opposite page; the reason being that this remote station is mounted 5 1/2 ft. high on the wall—ear-level while standing—which makes tuning more convenient.

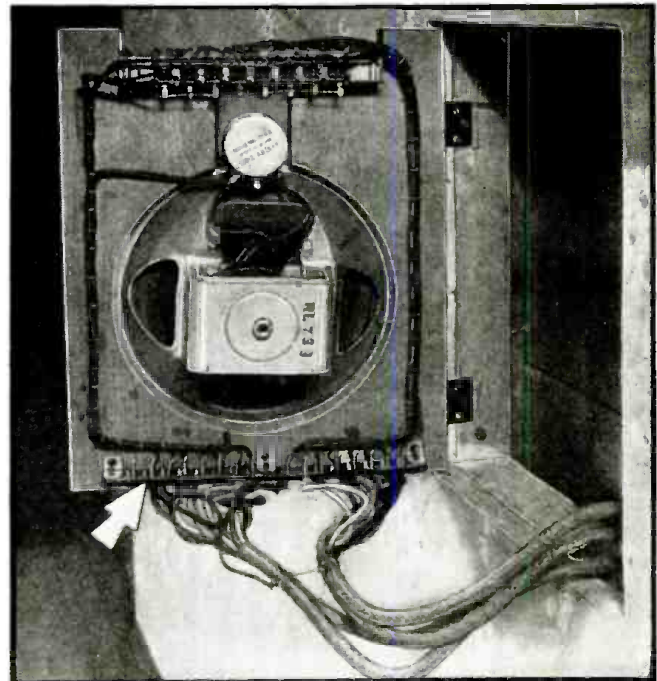
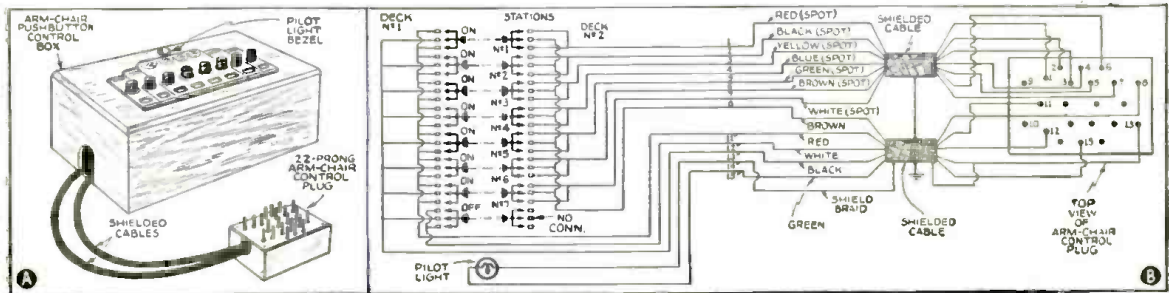

Fig. I. Here, one of the speaker brackets is swung out on its hinges to show the neat wiring and the connections to the wall cables. Note the 16-lug terminal strip (arrow). Servicing an installation such as this will be a pleasure rather than a headache since our components are readily accessible.

Fig. 7  
Details for making and wiring the armchair control unit. Note that this control unit does not have a volume control; otherwise, it would be in shunt with the wall-panel volume control.



# RADIO — at the

Radio men in every walk of the trade will visit either the Sun in the grand total of (approx.) 75,000,000 persons it is estimated CRAFT directs this Review. It is intended to acquaint the Fairs, and within practicable limits, the "behind-the-scenes" Fair opened Feb. 18, 1939; will close December 2. The New

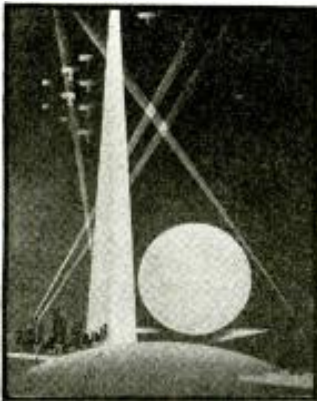

Symbolic study of the New York World's Fair 1939 "World of Tomorrow" Theme — the Tylon and Perisphere.



A 53-foot Elco motor yacht will be found in a specially-constructed marine basin in the gardens at the rear of the RCA exhibit building at the N. Y. Fair. You may operate the new radio devices for communication and safety at sea.

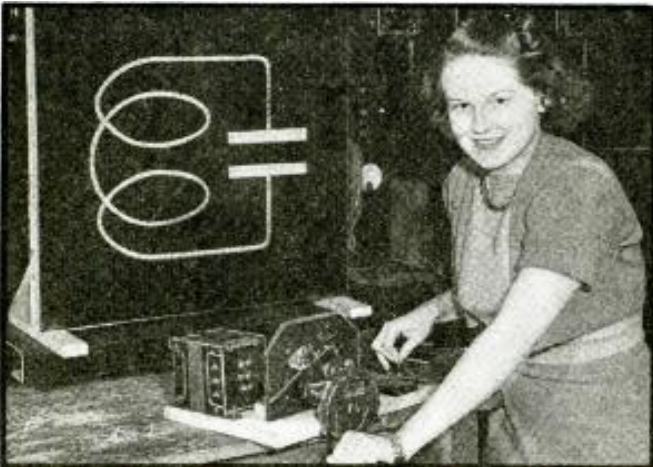

This fair-sex amateur radio operator soon to turn professional (upon completion of studies) is Kathryn Hutchinson, 16, of the famous "Flying Hutchinsons." She is here shown at RCA Institutes, at work on a unit of the amateur radio display being featured, with A.R.R.L. co-op., at the Westinghouse Exhibit at N. Y. Fair.

THE combination radio-public address system installed at the New York World's Fair is capable of simultaneous origination, monitoring, volume control and switching of 6 independent programs with separate distribution to 4 public-address channels and 2 radio channels. It is capable of either picking up electrical transcriptions or radio programs, or remote pick-ups, and transmitting these programs through its 4 studios to the 16 public-address outlets located at strategic points throughout the Fair's 1,216½-acre site. The real center of this vast system is located in the Communications Building.

Each of the 16 P.A. outlets scattered through the New York World's Fair grounds embodies 2 specially-developed RCA cube loudspeakers driven by four 50-W. amplifiers. The speakers measure 36 ins. on each side and contain separate low- and high-frequency driving units, and an associated cross-over network having an input impedance of 15 ohms. Both units are of the P.M. dynamic type. Four specially-constructed studios are used at the New York World's Fair for transmitting programs either over the air or over wires to the various P.A. stations located throughout the Fair area.

Studio A, 32 ft. long, 18½ ft. wide, 15 ft. high, is used for live orchestras and music presentations. Studio B is a speaker studio and has been especially designed to appear as a man's study, with easy chairs, desks, carpeting, books, etc.; it is 13 ft. square with a 15-ft. ceiling. Studios C and D are "Nemo" (remote control) studios, identical in size and equipment. They measure approximately 7 x 10 ft. with 10-ft. ceilings. Recordings and piped-in programs are transmitted from here.

The output fidelity of the New York World's Fair sound equipment is of the highest quality obtainable. The frequency response from input to output of its amplifying equipment is within ±2 db., from 30 to 10,000 cycles, without frequency compensation. Total harmonic amplitude distortion is less

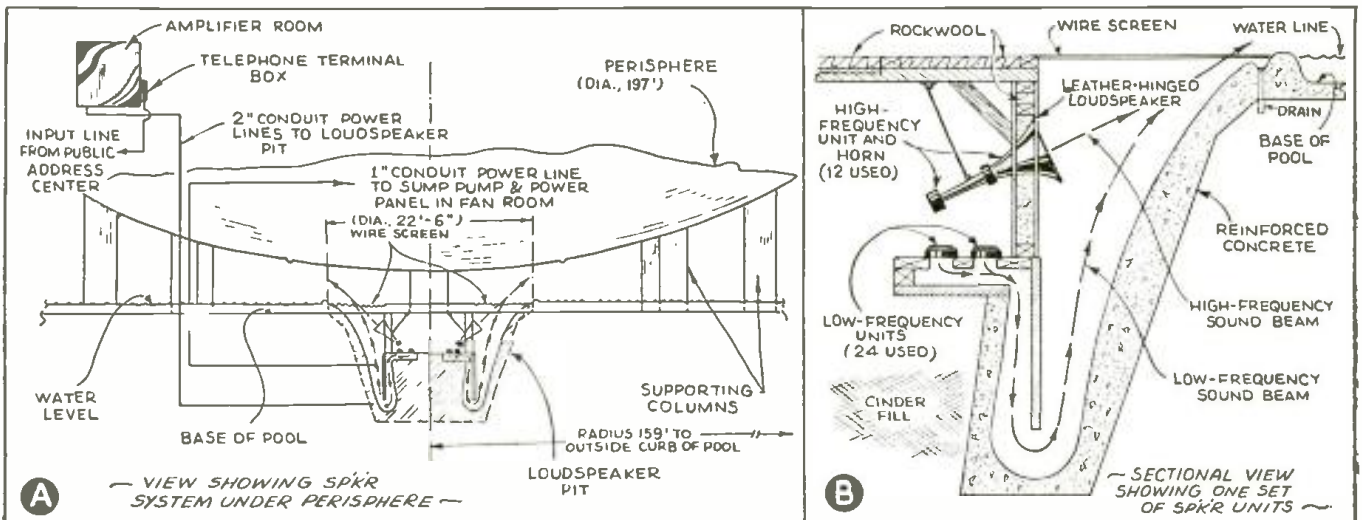

This loudspeaker, with a giant's voice capable of reaching 20 miles, utilizes the Perisphere portion of the Fair's Theme. For the first time in history, the outer surface of a building is being used as a gigantic exponential horn! (Illustration special to Radio-Craft.)

# World's Fairs

Francisco or the New York World's Fairs, or both. To this group, mated will attend these gigantic entertainment centers, RADIO-radio man with the major items of technical interest in the story of what makes the wheels go 'round. The San Francisco York Fair opened April 30, 1939, will close November 1.

than 1 per cent for any frequency between 50 and 7,000 cycles; this is, truly, an outstanding achievement in acoustics.

Perhaps the most spectacular aspect of the sound program at the New York World's Fair lies in the fact that for the first time in history the outer surface of a building is being used as a gigantic exponential horn.

Music of extremely high fidelity issues from the mouth of a "horn" formed by the outer curving surface of the 200-ft. surface and the flat surface of a 320-ft. pool of water beneath the giant globe. This extra "horn" arrangement has an unprecedented sound coverage around a horizontal angle of 360 degrees. It is capable of producing  $2\frac{1}{2}$  bars of sound pressure at 20 cycles-per-second at the edge of the pool.

The largest and most powerful loudspeaker ever developed, the "perisphere horn" can produce sound audible 20 miles away—if permitted to operate at full power!

The diagram at the bottom of pg. 720 clearly shows the location of the various high- and low-frequency speakers, the acoustical pit, and the general arrangement of all components forming the "horn." The illusion produced by this method of sound distribution is that of sound originating in space without any apparent source. The response of the perisphere horn sound system is flat over the frequency range from 20 to 8,000 cycles.

The pyrotechnic display which takes place nightly over the Lagoon of Nations is really a symphony of smoke, fire, water and light, the rhythmic motion of which is accompanied and enhanced by music and sound. The music and sound originate in a nearby auditorium and are "piped" through wires to a special sound projector system. This system, second only to the perisphere horn in power, is installed in 4 circular structures located 2 on each side of the center fountain ring.

Eight acoustic couplers, each consisting of a separate low-register or bass, and high-register or treble, element comprise the huge sound projector. The audio spectrum is divided into 2 parts, the separation occurring about middle "C." and separate amplifiers are employed to drive the units of the 2 registers in order to provide reproduction undistinguishable from the original. The 4 bass couplers, combined, are equivalent to a horn with a mouth opening 30 ft. square. This huge bass "horn" is actuated by eight 125-watt speaker units, each with a 24-in. diameter diaphragm and 500-lb. field magnet. The treble units are smaller but handle an equivalent amount of electrical energy. The total energy required to drive the sound projector of this Lagoon of Nations is 2 kilowatts (2,000 W.).

The components of the huge sound projector used for the fireworks display at the Lagoon of Nations are so arranged that the distribution of sound is stereophonic (or "3-dimensional," as in viewing stereoscopic pictures). The listener hears the electrically-transcribed music of the orchestra exactly as he would if the orchestra itself were present; and the relative locations of

Theme of the San Francisco World's Fair of 1939 is the "Tower of the Sun," located on Treasure Island in San Francisco Bay.

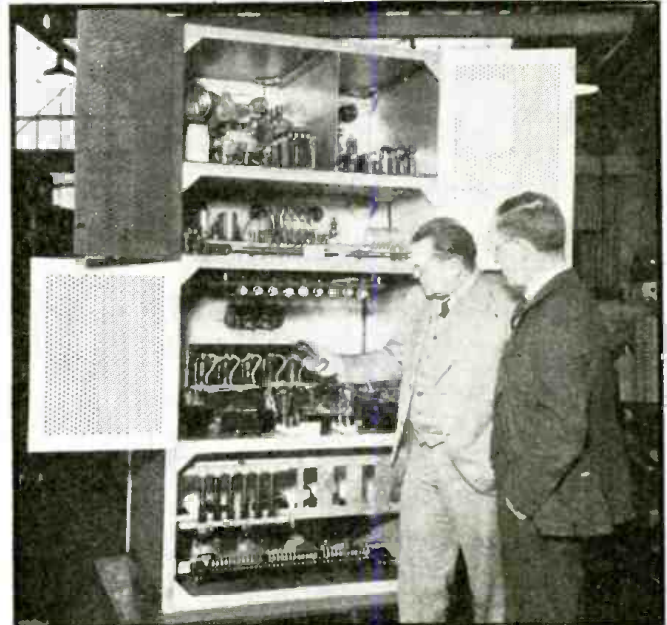

C. A. Priest (left) and C. H. Lang inspect the General Electric shortwave radio transmitter before shipment to Treasure Island, San Francisco World's Fair of 1939. This 20-kilowatt station, call letters W6XBE, has world-wide coverage.

the various instruments in the orchestra are plainly discernible because of the special effects peculiar to the stereophonic reproduction. This presentation is the first known example of "acoustic perspective" or stereophonic distribution. (Continued on page 752)

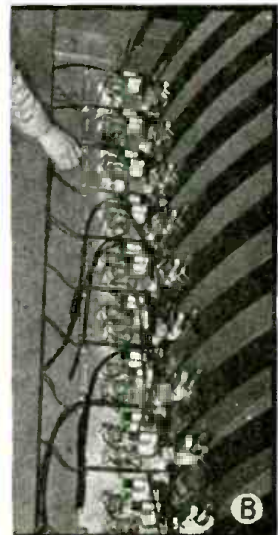
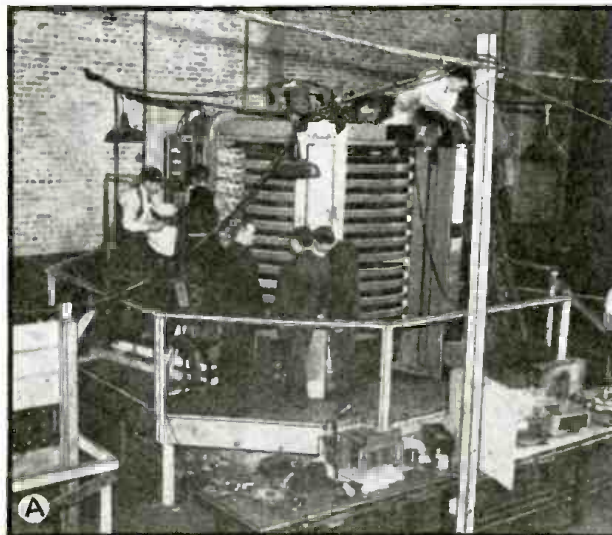

(A) Nucleus of the "Robot Guides" in the General Motors "Highways and Horizons" exhibit at the N. Y. World's Fair in this 20-ton rotor which revolves a dozen sound-on-film recordings past individual photocell sound pick-up units. Visitors seated in 600 chairs on an escalator hear individualized descriptions, from a loudspeaker on each pair of chairs, of passing scenery. (B) A close-up of the sound drum. Note the individual exciter lamps and photocells for each film; each pick-up has its individual A.F. amplifier. A total of 150 tanks is delivered from this set-up, said to be the most precise machine ever constructed by man (except for the 200-inch lens at Mount Wilson Observatory).

THE LIFETIME CORP.

SPRAGUE PRODUCTS CO.

# \$4,000 P.A. CONTEST

MONTGOMERY, WARD & CO.

UNIVERSITY LABORATORIES

[SECOND MONTH]

## \$4,000 Worth of Prizes

(Approximately \$1,000 in prizes per month for 4 consecutive months) will be given to **SERVICEMEN, RADIO DEALERS AND SOUND SPECIALISTS**

for **BEST** letters describing **ACTUAL PUBLIC ADDRESS SYSTEMS INSTALLED** During the Past 8 Months and up to the End of This Contest

OBJECT OF THE CONTEST

**PUBLIC ADDRESS** is now on the upswing and all indications point to a bigger sound business this coming season. In order to stimulate interest at this time in public address *(Continued on page 762)*

MILES REPRODUCER CO.



AMPLITONE PRODUCTS CO.

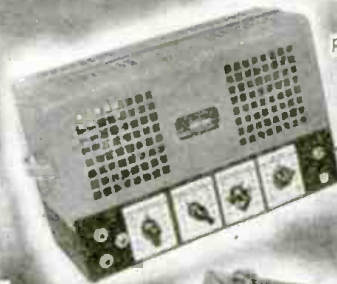

AMPLIFIER CO. OF AMERICA



CINAUDAGRAPH CORP.

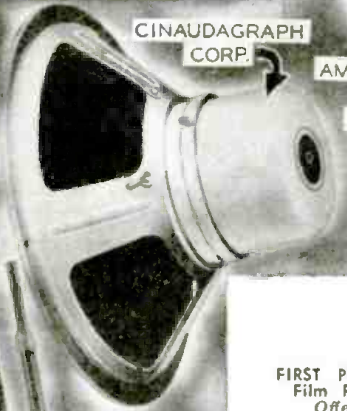

ATLAS SOUND CORP.

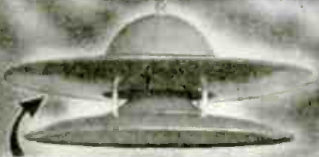

AMPERITE CO.



RADOLEK CO.



EASTERN MIKE-STAND CO.



LAFAYETTE RADIO CORP.



VOCAGRAPH SOUND SYSTEMS



ALLI D RADIO CORP.



VAC-O-GRIP CO.



### LIST OF PRIZES

- FIRST PRIZE—"Filmgraph" Complete Sound-on-Film Recorder, \$225.00  
*Offered by Miles Reproducer Company*
- SECOND PRIZE—Complete Mobile P.A. System, 28 W., type 32MP28SD, \$178.00  
*Offered by Vocagraph Sound Systems*
- THIRD PRIZE—50-60 W. Beam Power Amplifier, with tubes, ready to operate, \$136.50  
*Offered by Radolek Company*
- FOURTH PRIZE—25-W. Deluxe Amplifier, \$90.00  
*Offered by Montgomery, Ward and Company*
- FIFTH PRIZE—25-W. Deluxe Amplifier, type AM-25, \$71.00  
*Offered by Amplitone Products Company*
- SIXTH PRIZE—15-18 W. Amplifier, with tubes and cover, ready to operate, \$44.00  
*Offered by Lafayette Radio Corp.*
- SEVENTH PRIZE—Velocity Microphone, type RBHK, \$42.00  
*Offered by Amperite Company*
- EIGHTH PRIZE—8-W. Micro-Beam Amplifier, type ACA-8C, \$40.00  
*Offered by Amplifier Company of America*
- NINTH PRIZE—Velocity Microphone, type 90, \$30.00  
*Offered by The Lifetime Corp.*
- TENTH PRIZES—P.M. Dynamic Driver Unit, for air-column trumpets, \$30.00  
*Offered by University Laboratories*
- Assortment of Condensers, \$25.00  
*Offered by Sprague Products Company*

*(Continued on page 764)*

See! Hear! —

# AMERICAN TELECEIVERS for 1939

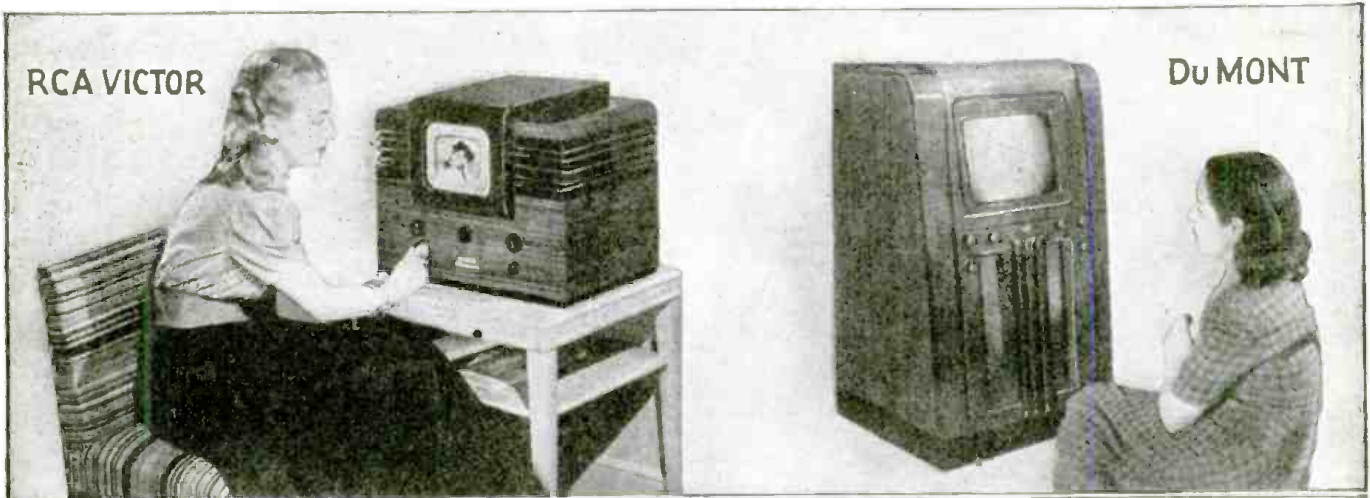

RCA VICTOR

Du MONT



GENERAL ELECTRIC

WESTINGHOUSE

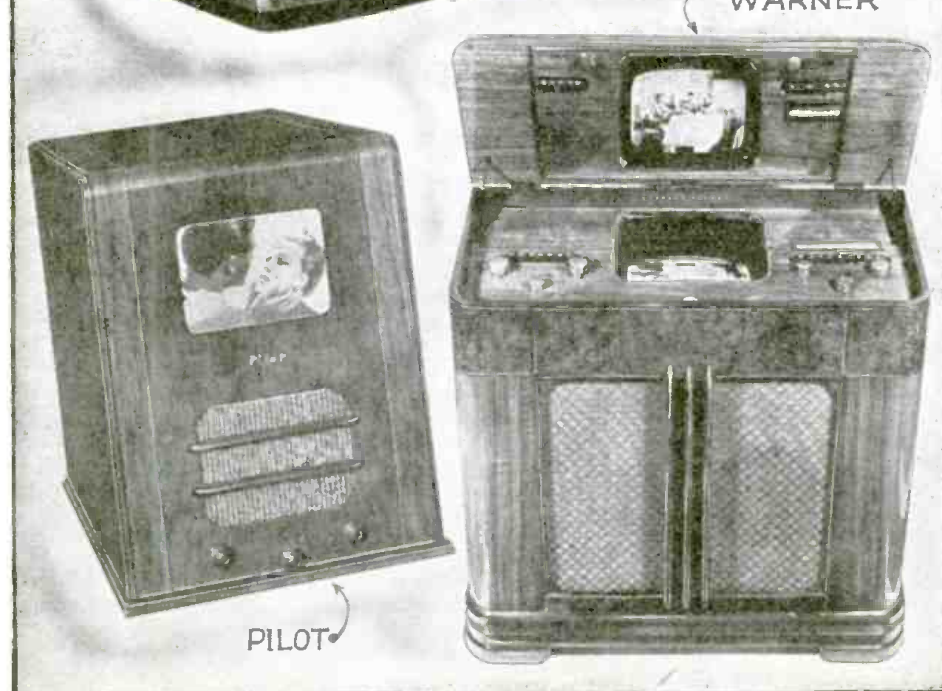

STEWART-WARNER

PILOT

**C**OINCIDENT with scheduled television transmissions by NBC/RCA at the opening of the New York World's Fair 1939 on April 30, foremost radio set manufacturers announced availability of new television receivers, and image-receiver — sound-converter units.

*Radio-Craft* here presents to its readers views of certain of these "teleceivers"—most of which are representative of an entire line—and the following review of these models, and the additional models where other models are available.

**RCA VICTOR.** Illustrated on this page is the RCA combined image receiver and sound converter, model TT-5. It employs a direct-viewing 5-inch kinescope (cathode-ray receiving tube) with an image which measures 3 3/8 x 4 3/8 ins. The chassis incorporates 16 tubes, plus the kinescope. Overall dimensions of this table model instrument are:

(Continued on page 744)

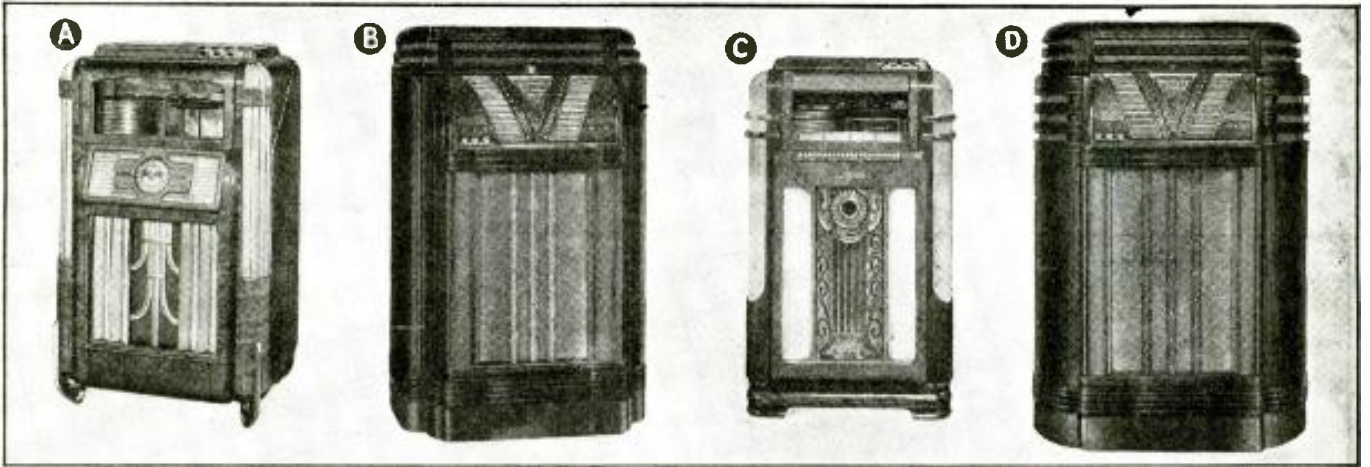

Here are some typical coin-operated phonographs: (A) Wurlitzer model 24, (B) Seeburg Casino, (C) Wurlitzer model 600, (D) Seeburg Plaza . . .

## A New Money-Making Field SERVICING COIN-OPERATED

*Clubs, grills, halls, roadside inns and many other places where people or a highly desirable form of entertainment, constitute an enormous electric phonographs. On 9 out of 10 calls it's the sound system that miliar. A former radio Serviceman, who now makes his living servicing*

**SANFORD**



**T**HE coin-operated phonograph, which made its modest debut 4 or 5 years ago, has gradually been changed from a simple coin-controlled selective record player to a mechanism which now involves *remote wireless coin boxes, remote wireless extension speakers and remote selectors.*

Formerly anyone handy with a screwdriver and possessed of slight mechanical inclinations could be counted on to keep these relatively simple machines in passable operating condition. But, alas, the coin-operated phonograph has come of age, rivaling the all-wave, automatic tuning, multi-speaker console radios in requiring highly skilled help in installation and maintenance.

Radio Servicemen would do well to consider the increased earning power possible in servicing these machines since many new features that are innovations in the phonograph field are old friends in disguise to the radio man. Phonograph oscillators, line carrier signals and wireless selectors hold no terrors to the trained radio mechanic. The writer, who could wield a wicked neutralizing wrench back in his radio servicing days, has found his experience exceedingly helpful in phonograph maintenance.

### BASIC ELEMENTS

Essentially, the coin-operated phonograph is a selective automatic record player holding 12, 16, 20 or 24 records on

trays, an electric pickup amplifier, and speaker. Inserting a coin closes a circuit which energizes a solenoid that turns on the amplifier and motor. The selected record is swung out of the stack by the motor and when it reaches the end of its arc it is raised by the turntable to engage the pickup. Volume is usually adjusted by a key-operated volume control on the back of the machine.

When the pickup reaches the end of the record the eccentric groove causes it to trip the changer mechanism, the turntable is lowered to the baseboard, the record returns to the stack and a cancelling arm shuts off motor and amplifier.

### QUICK-HEAT SYSTEMS

The period between the inserting of the coin and the playing of the record is about 5 seconds, and in order for the amplifier to be in operating condition in this short interval one of two systems is used. Either the amplifier uses filament-type tubes as the 30 and 45 which need no warm-up period; or, in the case of heater-types, such as the 6C6 and 6L6, a single-pole double-throw relay in series with the 6L6 cathodes delivers 9.8 volts to the tubes during the warm-up period and, as soon as the output tubes draw current, the relay clicks over to the 6.3-volt tap on the power transformer, cutting the warm-up interval to about 5 seconds.

A large percentage of out-of-order calls are due to electrical troubles in the pickup, amplifier or speaker and since this is familiar ground to the radio service fraternity, no difficulty should be encountered in making the necessary repairs. Experience has shown that a volt-ohmmeter is sufficient to locate these electrical troubles, and since the replacement parts necessary for amplifier repairs are the same as those carried in stock for radio repairs it involves no extra expense for test equipment or parts.

### STEP NO. 1

Since the coin-operated phonograph is a source of income to both the operator and the location, there is no compromise with 100% performance at all times. An operator confronted with an inoperative machine will not hesitate to call upon the local radio dealer rather than delay repairs. Phonograph

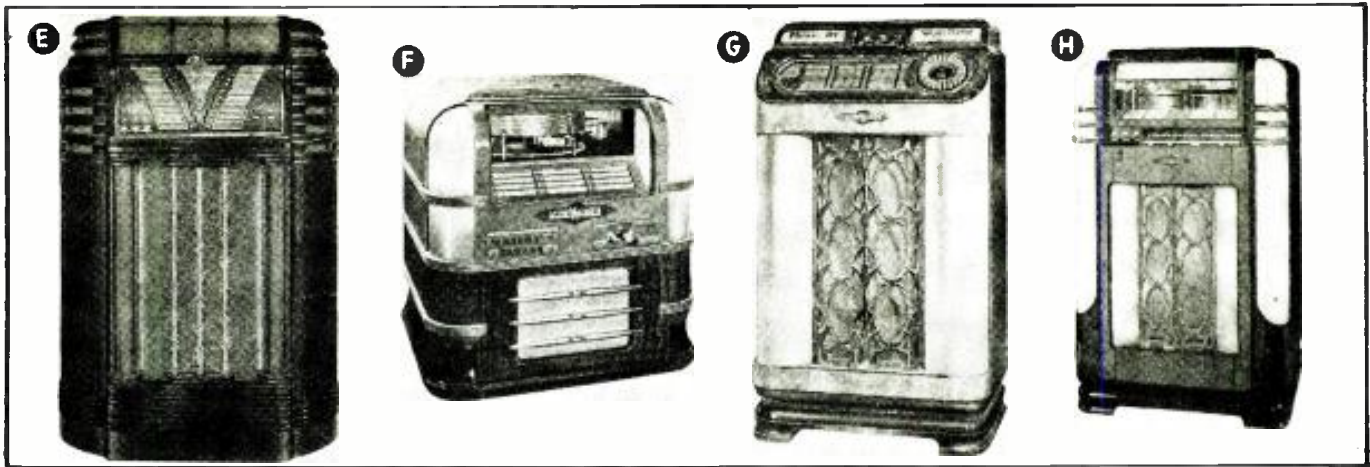

... Seeburg Mayfair, (F) Wurlitzer model 61, (G) Wurlitzer model 260, (H) Wurlitzer model 500 de luxe.

# For Servicemen! ELECTRIC PHONOGRAPHS

congregate and where instantly-available music is either a prerequisite market for the sale or rental, installation and service of coin-operated requires servicing—a job with which the radio man is thoroughly familiar in this field exclusively, discusses its pitfalls and how to avoid them.

## MILLER

No. 1

service manuals and instruction books continually stress the importance of having technical assistance in the event of trouble; and every operator sooner or later needs assistance, be it repairs, speaker installations, remote coin boxes, remote volume controls or the addition of microphones.

Those locations that own their own machines need periodic inspection, occasional repairs, tube replacements and frequent changes of records. The Serviceman equipped to handle these requirements will find them remunerative. Furthermore many operators would probably welcome the idea of referring out-of-order calls to a Serviceman in the vicinity in order to render the prompt service so essential to their business. This all adds up to a new field to conquer.

Let me show an instance of how important technical assistance can be to an operator stumped by a problem.

### TAVERN PROBLEM

A tavern owner who rented a coin-operated phonograph

to furnish music at the bar decided he needed an extension speaker for the dining room in the rear. He was also the owner of a restaurant located next door to the tavern and thought it a good idea to install 2 speakers to cover both places. The phonograph did not have sufficient power to drive more than 1 extension speaker. How to cover 2 separate adjoining rooms with recorded music on only a single 12-in. speaker stumped the operator.

The solution was simplicity itself. Since the 2 dining rooms were separated by a thin plywood partition a 10-in. opening was made in the partition and the speaker was securely bolted into place. A large grillecloth, previously placed over the front of the speaker was now neatly gathered at the corners and tied back to cover the rear of the speaker. Thus the front of the speaker filled the restaurant with music, and the rear of the speaker covered the tavern dining room; and the partition itself made a swell infinite baffle.

(Continued on page 751)

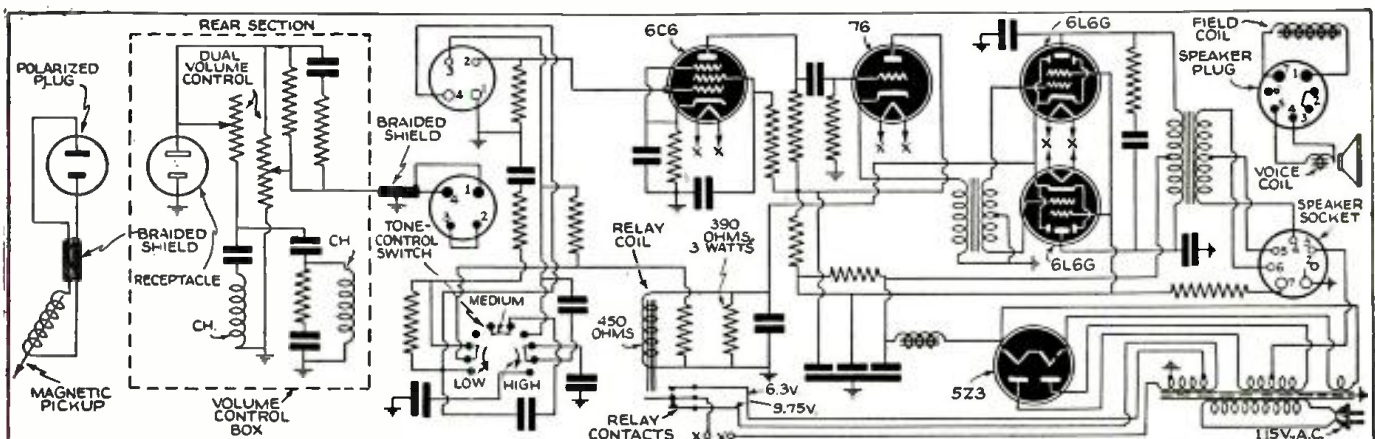

Radio Servicemen will recognize this as a diagram of an amplifier—yet it is the heart of a typical coin-operated electric phonograph (Wurlitzer model 24). The mechanical devices of these machines seldom get out of order. But the electrical parts do. Why, therefore, should not the radio Serviceman include the servicing of these phonographs among his profitable activities.

# BUILD THIS *Switchless*

*A practical set-up for an ideal system of communication, which eliminates the necessity of "Talk-Listen" switches during conversation.*

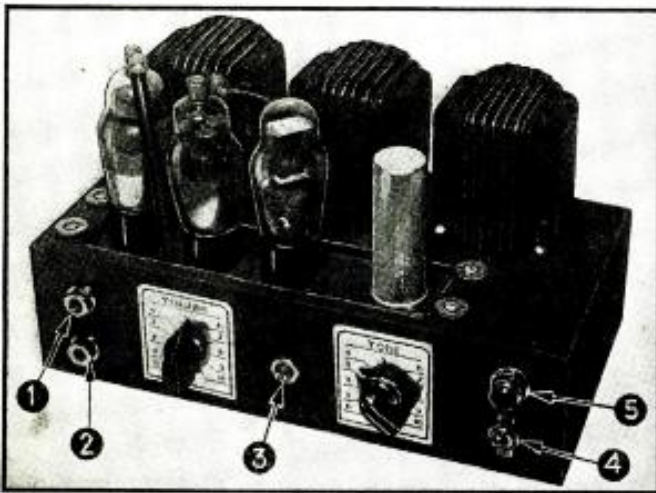

The "heart" of the new interphone system is this amplifier. Numbers 1 and 2 indicate the jacks for the 2 stations; No. 3 is the line balancer; No. 4 the on-off power switch; and 5 the power light bezel. These stations can both talk and listen at the same time.

**T**HE problem of inter-office communication has received a considerable amount of attention during the past 8 years. If one carefully traces the development of this industry it will be found that comparatively little time was given to the development of a system which would enable amplified loudspeaker communication, between two or more remote points, without the necessity of manipulating "Talk-Listen" switches.

Although previous attempts have been made to employ two separate amplifiers, each with their individual microphones and speakers so arranged that a constant flow of conversation could be maintained without switching, the feedback problem was a serious drawback. This, of course, necessitated the acoustic separation of the microphone from the speaker so as to avoid any sustained feedback condition. Naturally, while a system of this type may be easily perfected, it involves higher costs and great care in the design of each station so that the speaker and microphone may be housed in one compact cabinet. Non-amplified systems using transformers and batteries only, have been developed in an attempt to solve this problem. The quality of reproduction, however, of such systems falls short of natural reproduction.

## ACOUSTICS

If an impartial analysis be made of a series of conversations conducted during normal office routine, the following conditions will be noted:

- (1) A continuous flow of conversation takes place without abrupt starts or stops.
- (2) Interruptions are made by one or both of the speakers.
- (3) No physical co-ordination is required to shift the conversation from one person to the other.

If an ideal *inter-phone* (inter-communicator) is to be developed, it must provide for conversational facilities closely approaching those encountered during normal face-to-face conversation. The closest approach to this ideal is encountered in telephone systems, wherein it is possible to maintain a continuous flow of conversation between two or more persons without mechanical interruptions at beginning or finish of each quotation. Telephone systems, however, divert from the ideal, when both volume and the mechanical neces-

sity of holding a receiver to the ear, and microphone to the mouth, is considered.

To produce the closest approach to ideal communication, all of the advantages of the telephone circuit were used, plus an amplifier to enable loudspeaker communication. Although two separate amplifiers were originally used, it was found that the design of the cabinet housing the speaker, microphone, and amplifier was unusually critical, inasmuch as it was necessary to incorporate more acoustic attenuation (in db.) between each microphone and its associated speaker, than was represented in the gain (in db.) of the amplifier.

## A PARADOX

A study of the problems involved in all previous experiments, pointed to the development of a practical communicator which uses a single *transducer* or "combination" speaker-and-microphone at each remote station, and one amplifier having the components so arranged, that sound energy originating at either remote station, would feed into the amplifier, to be amplified and then subsequently appear at a louder level at the other remote station; this action to take place in both directions, and simultaneously, if necessary. It therefore follows that it is necessary to connect the "combination" microphone-and-speaker to the input and output of the amplifier at the same time. Although it seems impossible to achieve such a state of affairs, without producing a continued state of singing or howling, it has been done by the use of a *carefully-balanced bridge circuit* between the input and the output sections of an amplifier.

## BRIDGE CIRCUIT

In order to understand the development of the completed circuit as shown in Fig. 1, it would be best to follow the evolution of the balanced bridge circuit as outlined in Fig. 2.

The necessity of providing a 2-way transmission feature over 1 pair of wires has, of course, been solved by telephone companies, by the use of a bridge circuit, involving a *hybrid coil*. This hybrid coil operates on the familiar "impedance bridge" principle, as follows:

In Fig. 2A, if the corresponding elements *a*, *b*, *c*, *d*, are identical, the bridge will be balanced, and any voltage applied at *E* will not be audible in the headphones, *P*. If the circuit is now arranged, as in Fig. 2A, it can be demonstrated experimentally, and proved theoretically, that no difference in potential will exist across the headphone terminals as long as the bridge remains balanced. For a balanced condition, *a* and *b* must be identical, and *d* and *c* must be the same. Any difference between either of these values will cause a corresponding unbalance, and introduce a signal into the headphones.

If, as in Fig. 2C, the arms *d*, *c*, are replaced by 2 identical inductances, the balance will still be maintained, and no signal heard at the phones. It is furthermore possible to substitute 500-ohm line output transformers connected to their respective speakers, in place of the *d*, *c*, arms as shown in Fig. 2D. Likewise, the arms, *a*, *b*, may be replaced by inductances without introducing any unbalance in our original bridge circuit. If, instead of normal inductances, transformers are used, so that the applied signal voltage is isolated from the bridge circuit, our new arrangement will be similar to Fig. 2F. This last bridge circuit is essentially the arrangement used in the hybrid coil (sometimes called "bridge transformer"); the circuit has been redrawn in Fig. 2G to represent the actual conditions more closely.

## HYBRID-COIL CIRCUIT

When a sound wave strikes the diaphragm of the "combination" microphone-speaker at Station 1 (Fig. 2G), it is





# 2-WAY INTERPHONE!

● A. C. SHANEY

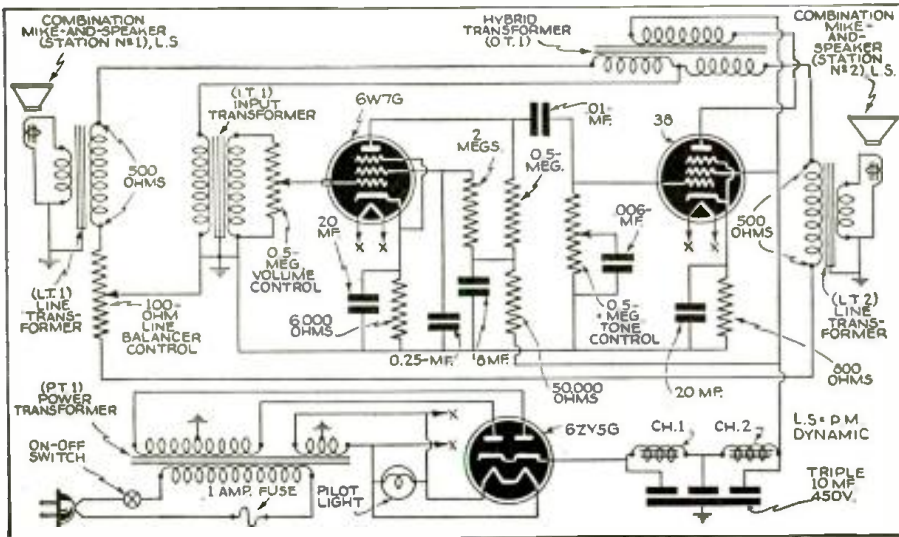

Fig. 1. Schematic diagram of the switchless 2-way interphone system. Notice that both the input and output circuits of the amplifier are connected to the hybrid transformer, making possible simultaneous transmission and reception of speech.

converted into electrical energy, which appears in the secondary of the coupling transformer, *c*. This impulse is then impressed across one-half the impedance of the hybrid coil *a* and the input of the amplifier. That portion of the voltage (which represents nearly all of the original signal) which appears across the amplifier input, is subsequently amplified and reintroduced into the bridge circuit through the output of the amplifier, and its associated hybrid coil (which now becomes the output transformer). This amplified impulse must not again introduce energy into the input circuit, or continuous oscillations will be produced and the entire system will howl. The action and requirements are similar for an impulse originating from Station 2. There are then 3 sources of voltage to consider: 1st a voltage developed at *c*; 2nd, a voltage developed at *d*; and 3rd, a voltage impressed at *a*, *b*.

It will be noted that the voltage impressed at *c* represents a signal from Station 1. The impressed voltage will cause current to flow through *a* and the input circuit of the amplifier. The amplified version of this signal appears in the output transformer, and is then induced into coils *a* and *b*. Inasmuch as *a* and *b* are linked by the same flux, and wound in opposite directions, a voltage will be induced, in each of these coils, of equal potential but opposite in phase. These voltages then pass through their respective *c* and *d* branches of the station transformers; and cancel at the ground terminal of the amplifier input. When this condition occurs, no current flows through the center-tap of *a*, *b* and ground, thereby eliminating possibility of the amplified signal feeding back into the input of the amplifier. A similar

cancellation of amplified voltages takes place at the input of the amplifier when signals originate at Station 2.

## THE LINE BALANCER

Under actual operating conditions, the amplifier may be placed anywhere between remote stations. A *line balancer* is employed, however, to equalize the differences in length of line, should such a discrepancy occur. It is important that both lines present identical impedances and frequency characteristics, to avoid feedback. This condition can easily be met by designing the secondary of the line transformer for 500 ohms if lines are long, or 50 ohms if lines are short. The line balancer can then easily be adjusted for maximum stability.

## THE AMPLIFIER

Aside from the hybrid transformer, the amplifier circuit (Fig. 1) follows conventional lines, utilizing a 6ZY5G full-wave cathode-type rectifier to supply current to the type 38 pentode power amplifier, which is coupled to a 6W7G high-gain pentode amplifier. Precautions should be taken to use a hum-bucking type of input transformer so as to avoid hum pick-up from the power transformer.

## "MIKE-SPEAKER" UNIT

Any standard permanent-magnet loudspeaker, having a good frequency response characteristic, will serve for the "combination" microphone-and-loudspeaker. No special precautions need be followed in mounting this unit into any convenient cabinet. The fidelity of the system will, in a large way, be dependent upon the speaker employed,

(Continued on page 751)

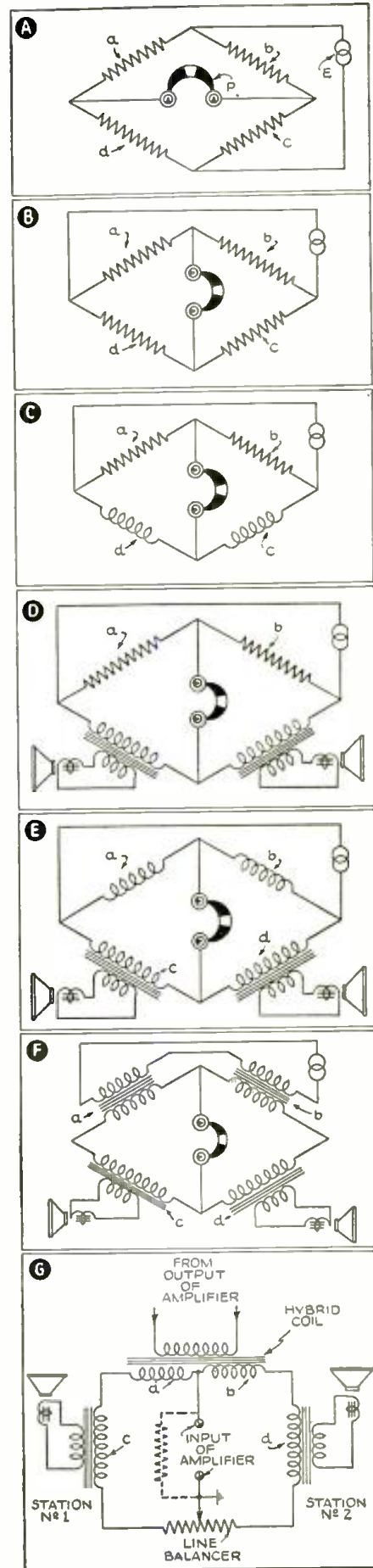

Fig. 2. These diagrams show step-by-step how the bridge circuit used in this interphone system was evolved. (See text for details.)

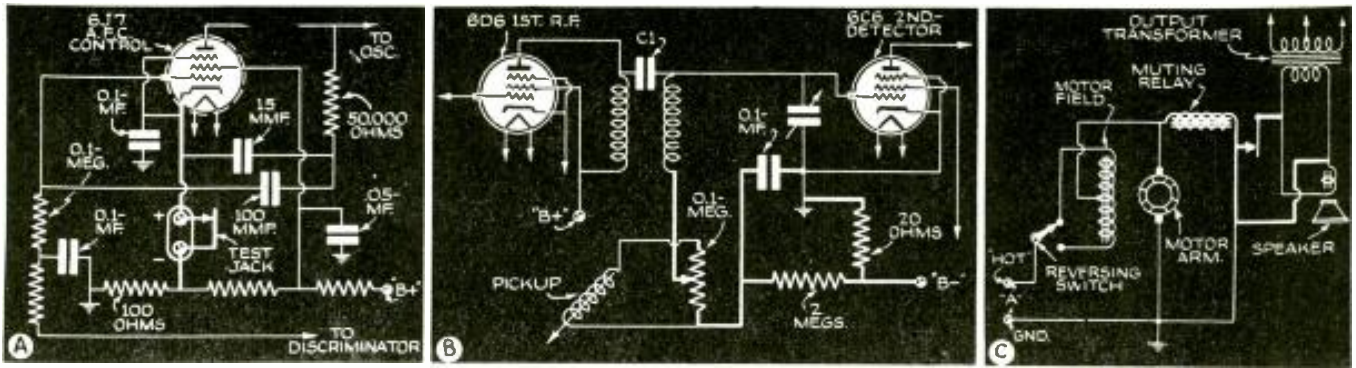

Fig. 1. New circuit features of (A) Knight Models A-9757, A-9758; (B) Detrola Model 208-AP; (C) Motorola Model 8-80.

## NEW CIRCUITS IN MODERN RADIO RECEIVERS



*The details of the modern radio receiver circuits that make them "different" from previous designs are illustrated and described each month by a well-known technician.*

F. L. SPRAYBERRY

NUMBER 21

### (1) A.F.C. TEST JACK PROVIDED TO FACILITATE OPERATING TEST OF A.F.C.

Knight (Allied Radio Corp.) Models A-9757 & A-9758. *Instead of breaking the circuit anywhere to test the performance of the A.F.C. tube, so that the adjustment of the receiver and the discriminator may be judged, a special jack by which the plate current of the A.F.C. control tube can be measured is provided in the circuit.*

The operation of the A.F.C. tube is based on the changing of its grid bias above and below a specified operating value. The discriminator provides a small positive or negative voltage which is in proportion to the amount the signal is off resonance. This bias makes the A.F.C. tube change the oscillator frequency so that near-resonance can again be achieved.

Now the A.F.C. control voltage is small and is produced across a very high resistance so that it is not easily measured. However, the plate current of the A.F.C. tube is a definite index of the tube's bias and is quite easily measured if facilities are provided.

A sensitive D.C. milliammeter or mi-

croammeter is placed in the jack, Fig. 1A, and the current will be observed to increase or decrease while tuning-in a station on the receiver. By noting the average plate current for no station being received, you can easily make the proper adjustments so that in tuning across a station the meter will swing equally below and above the average or normal point. The adjustment is correct when the meter needle does not move when the A.F.C. switch is turned off and on.

### (2) PERMANENT PICKUP WIRING WITH NO CHANGE-OVER SWITCH

Detrola Model 208-AP. *The pickup which is used for phonograph reproduction on this set is permanently wired in place and may be used by simply setting in place and adjusting the volume.*

It will be observed in Fig. 1B that when the phono-pickup volume is adjusted to minimum, the grid tuned circuit of the 6C6 detector is closed through the pickup leads and the 0.1-mf. condenser. This condenser not only completes the bias circuit but isolates the grid from ground so that a

bias may be applied and yet the tuning circuit may be completed to ground. It closely resembles the bias system of any A.V.C. circuit.

As an audio amplifier the detector is not unlike any resistance-capacity coupled amplifier. The grid coil simply acts as an R.F. choke and the coupling condenser C1 has essentially no effect as it is hardly larger than the grid input capacity of the detector tube. During audio operation, the 0.1-mf. condenser and 2 meg. resistor compose a conventional grid-return filter.

When Radio reception is desired, the pickup control is simply turned to zero setting and the desired station is tuned-in. The detector action is rather unusual. The complete detector action is neither plate- nor grid-type detection, but is divided between the two. The grid circuit handles the rectification, but because of the large value of the isolating condenser (0.1-mf.) and 2 meg. resistance, cannot retain A.F. across it. The R.F. rectified pulses are therefore transmitted to the plate, it being the duty of the plate circuit to filter them. It is not

*(Continued on page 757)*

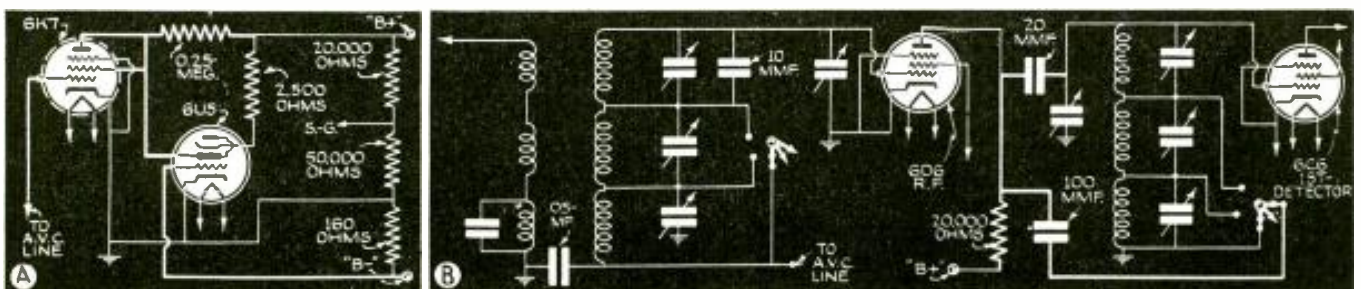
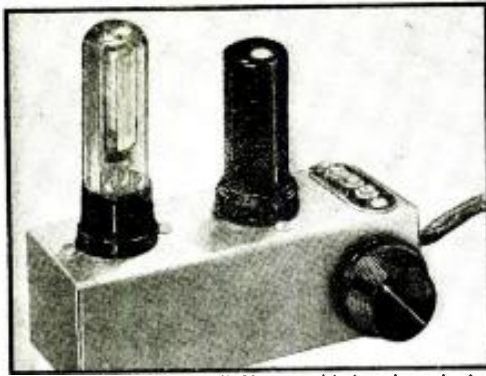
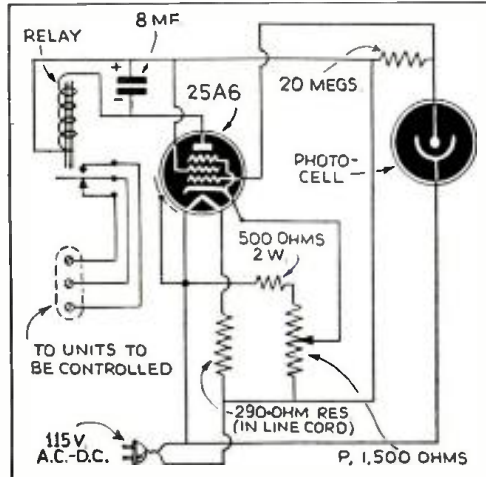

Fig. 2. New circuit features of (A) Garod Models 3012 and 4012E Series; (B) Montgomery Ward Models 62-402, 62-1101.



The simple "electric eye" kit assembled and ready for operation. The photocell is the tube on the left.



Schematic diagram of the photoelectric relay circuit.

*Easily Assembled*

## "ELECTRIC EYE" KIT

*It is easy to build a light-operated photocell device having many uses — another good side-line item for Servicemen.*

M. N. BEITMAN

**S**INCE photocell ("electric eye") equipment employs radio parts, the construction of such devices should be of interest to all active experimenters and Servicemen wishing to increase their activities in new fields.

Commercially, the photocell has taken the place of the Aladdin's lamp, performing a multitude of functions automatically that previously required the skill and attention of human beings. Our present-day sound movies are dependent upon the action of a photocell. For smoke control in industrial plants, counting, sorting and checking, for alarm systems, and for color matching and illumination analysis the *electric eye* has no equal.

While a mystery seems to cover the field of photocell design and the equipment needed suggests prohibitive prices, actually there are many extremely simple but efficient photocell circuits, and the cost—well, the kit illustrated can be purchased for about \$6, tubes and all.

### ABC OF THE ELECTRIC EYE

Any photocell unit must use a light-sensitive tube to change the light intensity or color variation to corresponding electrical energy. The ordinary radio type of vacuum tube emits electrons because the cathode element is heated directly or indirectly. Photoelectric cells, on the other hand, depend on electron emission caused by the peculiar reaction of certain metals when in the presence of light rays. These metals include caesium, lithium, potassium and sodium. Usually the hydrides and oxides of these metals are used in the photoelectric cells. The sensitivity to different colors and the general reaction characteristic of any cell depends on the emitting material used as

*(Continued on page 756)*

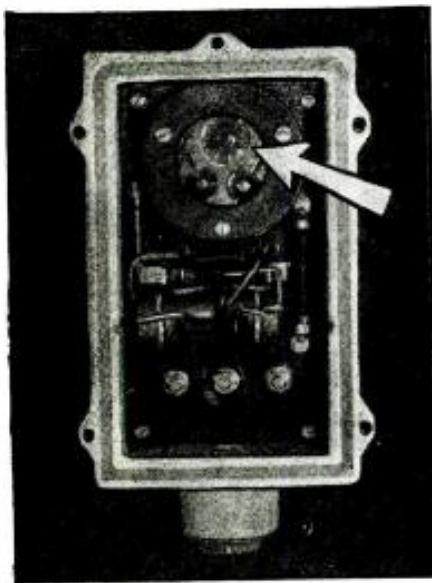

The radically new photoelectric cell (arrow) in its housing and with its associated components.

*Radically New!*

## Combined PHOTOCELL—RELAY

*In the space ordinarily occupied only by the photocell a French inventor has included a novel gas-operated circuit-closing relay. The translator's article was prepared from reference material supplied to RADIO-CRAFT by the French manufacturer.*

**T**HE use of light-controlled devices employing photocells has been limited by the cost of the accessories; and often by their unreliability rather than the cost of the photocell itself.

A new type of light-sensitive relay lately developed, known as the Chilowski Relay, appears to be simpler, cheaper and more dependable.

### FEATURES

The most striking features of the new

**HENRI F. DALPAYRAT**

device are its small size, barely larger

than a match box, and the absence of vacuum tube amplifiers, source of high voltage, and electromagnetic relay.

It is, however, not as rapid as a photocell but is well suited for a wide variety of purposes especially for the switching of lights, on or off, as day breaks or night falls.

Among its applications are automatic switching of street and road lights, window displays and advertising signs, and at aviation fields, etc. A feature of particular interest to the general public is the switching of automobile lights, automatically, when night falls, during the absence of the driver, thus reducing the hazards of accidents and the possibility of receiving police summonses.

The manufacturer of this device is the Société Tubest of Fère-en-Tardenois, France. Known as the Chilowski Photo-Relay it is commercialized under the trade-mark of "Tubest."

*(Continued on page 761)*

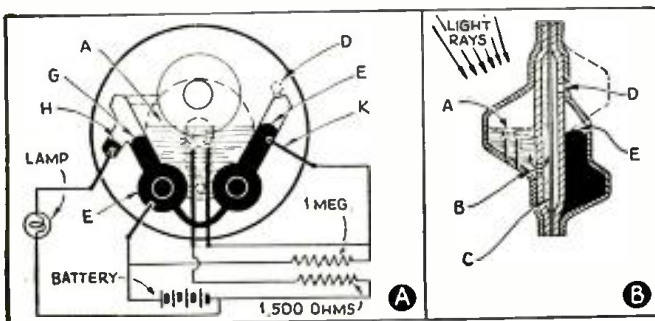
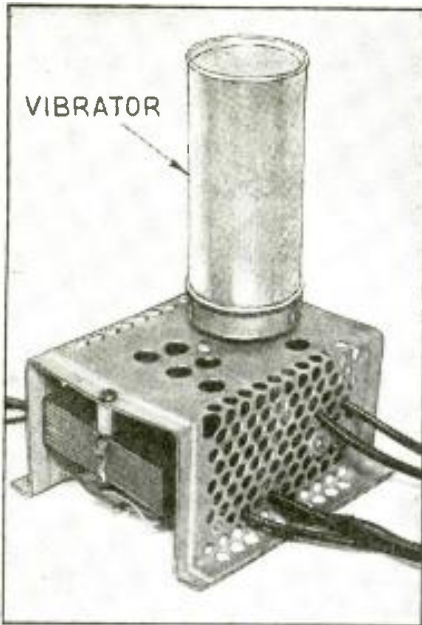
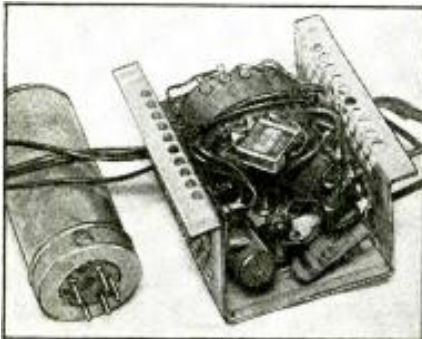

Fig. 1. (A) Diagram of front view; and, (B) cross-section view of the new photoelectric cell. See text for explanation of reference letters. The cell is a photoelectric gaseous device operating directly as a circuit breaker without amplification or electromagnetic relay.



Completely assembled vibrator unit for obtaining from one cathode-ray tube practically the equivalent performance ordinarily requiring 2 such tubes. Many applications of this arrangement important to Servicemen are described by Mr. Piety.



Underside view of the compact "vibrator switch" required in double-tracing your oscilloscope.

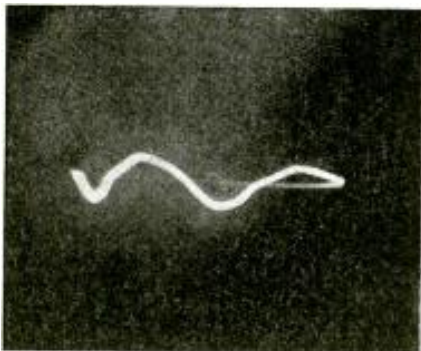

Fig. A. Unretouched photograph of the original non-sinusoidal wave applied to a type 902 tube.

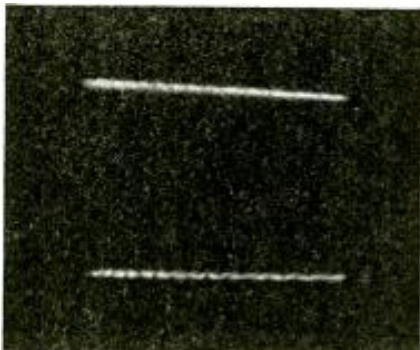

Fig. B. Here you see the effect of the "vibrator switch" when connected and operating but with no signal applied.

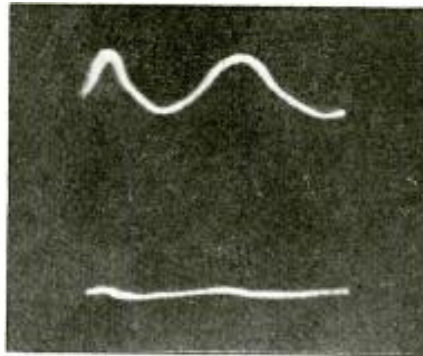

Fig. C. Signal applied to one input while the other is open leaving input No. 2 ungrounded results in departure from a straight line.



Fig. D. Image is not quite stationary as the trace skips from one axis to the other thus producing a "waterfall" effect.

# DOUBLE-TRACING

*A simple, practical, and inexpensive method of no major equipment changes and very little*

HARL

## 2-TIMING YOUR OSCILLOSCOPE

**D** ID you ever need 2 oscilloscopes? Haven't you, tracing distortion or hum, often wished you could lay 2 curves down side by side and compare them? The simple, inexpensive device described here enables you to do just that. You can secure 2 traces simultaneously (apparently), from 2 independent sources and with no interaction!

For instance, you may view both the overall selectivity and the discriminator response curves of an A.F.C. set at the same time; or compare a curve at the input with that at the output of a stage. The only requirement is that the curves be made stationary with a single sweep frequency; that they be either the same frequency or multiples or harmonics of the same frequency. This is always true in cases such as those mentioned above. This instrument automatically places one curve above the centerline of the screen and the other below, spreading them as though only one curve were being viewed, and keeping both separate. Comparisons for waveform distortion may easily be made, or the effect of a single adjustment may be observed at two different points simultaneously.

## WAVEFORM COMPARISONS

The accompanying illustrations are unretouched photographs of various combinations of the same voltage applied to a 902 tube through the device. Figure A is the original wave, applied in the usual fashion. You may notice that it is *not* a true sine wave. The amplitude is 9.1 peak volts. I believe the prints themselves are clear enough to prevent any suspicion of misunderstanding, I can only assure you they are *not* double exposures.

In Fig. B we see the "gadget" connected and operating, but with no signal applied and both input leads grounded. The displaced axis lines are clearly shown.

Figures C and D show the signal applied to one input, while the other is

open. The fact that input No. 2 was ungrounded and picking up strays at the time the photo was made accounts for the departure from a straight line. In Fig. D the image was not quite stationary. The coupling lines as the trace skips from one axis to the other, usually unnoticeable, may be seen in this picture forming a "waterfall" effect.

Figure E shows the signal applied to both inputs in-phase (image moved slightly during exposure); while in Fig. F the voltages are 180 degrees out-of-phase.

Figures G, H and I illustrate one important point, that synchronism must be with the signal, not the vibrator. They show 1, 2 and 3 cycles, respectively, of the vibrator with the signals applied in-phase.

## THE "AUTOMATIC SWITCH"

The "heart" of the unit is a common *synchronous vibrator*. It functions as a rapid automatic switch, connecting first one input, then the other; and at the same time changing the polarizing voltage of the vertical deflecting plate so the images are separated. The sketch, Fig. 1, shows the theory of operation. As this sketch shows, there is only one trace, but it is equally divided by the vibrating contacts between the upper and lower levels. The dotted portions of the curve are traced later as the "holes" in the curve drift across the screen. They (the dotted parts) are visible to the eye because of the "persistence of vision" phenomenon. The solid lines show the trace for 2 cycles of the vibrator.

Starting at the left of the screen, contact No. 1 (of Fig. 2) is closed. This applies a steady D.C. bias potential to the vertical deflecting plate so that the axis becomes temporarily the line *p-q* (in Fig. 1). The voltage being observed is applied at the same time, and so, instead of tracing a straight line the beam starts the curve in obedience to the input signal. The instantaneous voltage affecting the deflecting plate at

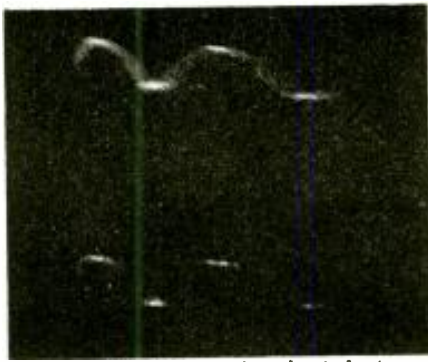

Fig. E. Signal applied to both inputs in-phase.

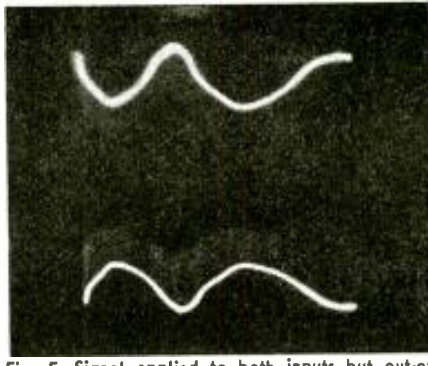

Fig. F. Signal applied to both inputs but out-of-phase 180°.

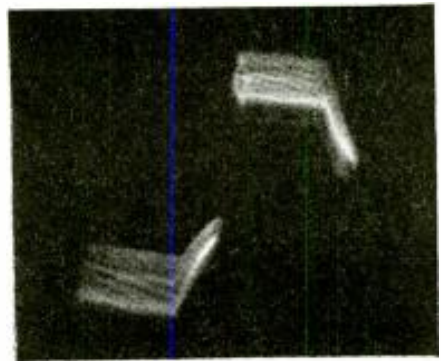

Fig. G. A single cycle of the vibrator—signals in-phase.

# YOUR OSCILLOSCOPE

viewing two traces on one cathode-ray tube, at the same time, entailing construction. Experimenters will be interested in the method used.

## O. PIETY

any moment is the sum of the polarizing voltage and the signal voltage.

At point *a* (Fig. 2), contact No. 1 opens and No. 2 closes. The signal applied to No. 2 is also added to the polarizing voltage, but No. 2 has a negative voltage applied to it so the beam is deflected downward and traces the curve supplied by Input No. 2 about the temporary axis *x-y* (Fig. 1). At *b* the contacts have reversed again and the curve of Input No. 1 is progressing about axis *p-q*.

This diagram (Fig. 1) also illustrates one limitation of the device. It is evident that there will be gaps in both curves if the trace is synchronized with the vibrator. (See Figs. G, H and I.) At all other frequencies, however, these "holes" in the trace are constantly shifting so the entire curve is available for inspection. When the instrument is operating properly one may notice small "gaps" that drift across the screen, but their speed is usually great enough that for all practical purposes they do not interfere with the pattern. When viewing a 60-cycle trace these gaps appear almost as air bubbles in a transparent tube of flowing oil. They are obviously there, and show clearly, but seem to "stay on" the trace.

### PRIME REQUISITES

The success of the device depends on the fact that the vibrator is on-contact most of the time. The vibrator *must* be a perfect one. Use of the oscilloscope is essential in adjusting the circuit during construction. The vibrator curve must be flat-topped and uniform to prevent distorting the dual images it establishes. The exact values of load resistor and buffer condenser (in the secondary winding of the vibrator transformer) will probably have to be arrived at through trial and error. The values on the diagram worked for my vibrator and transformer but may not for yours. The 0.5-meg. resistors in series with the polarizing voltage are merely current limiters which serve this function in

case of shorts. Blocking condensers are inserted in the input leads to avoid any possibility of shorts there.

There are many variations of this idea. You may want to insert an amplifier in each input lead in order to handle lower voltages. You may use a small power supply for bias instead of the "B" batteries we used in the experimental setup. Any and all of these plans will work, with certain precautions.

First, the polarizing voltage must be applied *directly* to the cathode-ray tube's vertical deflecting plate. It *will not* pass through amplifiers or blocking condensers as an A.C. signal will. If your oscilloscope does not have this connection brought out to the panel it will be necessary for you to go to the socket for it. *Just be sure the juice is off.* You may want to vary the polarizing voltage to obtain greater or less separation of the secondary axes; we found 45 volts, though, to be the optimum for both the types 913 and the 902 tubes. It may be possible to connect a rectifier tube to the secondary of the transformer and obtain voltage for both polarization and the amplifier tubes, too, so that the entire unit may be operated from a 6-volt supply.

You may not use the "gadget" on every job, but I'm sure the pleasure and possibilities it offers will more than repay the small cost of construction.

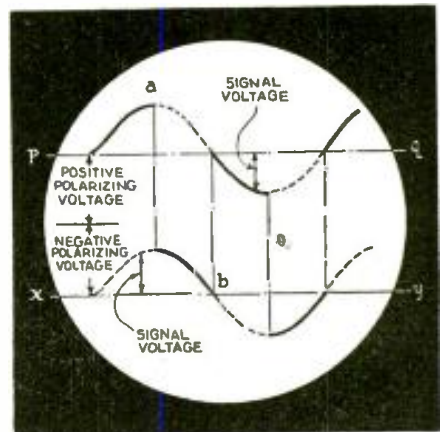

Fig. 1. Waveform of a single cycle; illustrating how first one image *p-q* and then a second *x-y* are set up during a single cycle by means of the "switch."

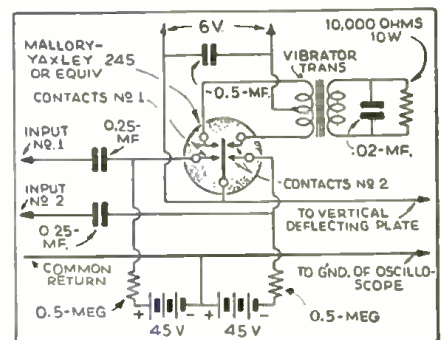

Fig. 2. Schematic circuit of the vibrating switch.



Fig. H. A 2-cycle motion of the vibrator—signals in-phase.

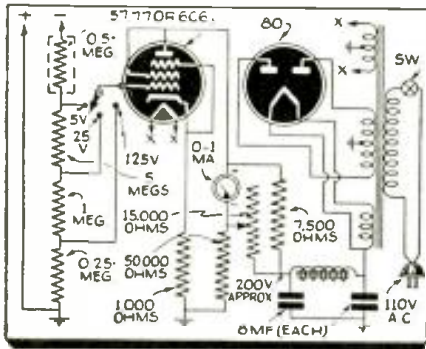

Fig. I. A 3-cycle motion of the vibrator—signals in-phase.

# USEFUL KINKS AND CIRCUITS

Contributions to this new department are paid-for at space rates; what previously-unpublished ideas to help fellow Servicemen, experimenters, etc., do you want to submit? A short description and pencil sketch will do.

## THE BUSY SERVICEMAN'S V.-T. VOLTMETER



● SERVICEMEN who have never used a V.-T. voltmeter have no idea what a time saver this instrument is or how comforting it is to merely put a test prod on the grid of a tube, whether it is resistance-coupled or not, and read the absolute voltage there. This also applies to tubes in A.V.C. circuits where a leaky or shorted bypass condenser is easily and quickly located.

As stated before in *Radio-Craft* (Oct., '38) most V.-T. voltmeters have some technical or mechanical drawback, but the largest drawback is the cost of the ready-built unit, or the cost of parts and the time required to gather and assemble the unit. My unit, however, I built in only an hour; and, since I used a small radio set to get the power system and an 0-to-1 ma. meter that I already had, cost me less than \$1.

This unit is a direct-reading, 0-5-25-125V. D.C., V.-T. voltmeter with an impedance of nearly 7 meg. on all ranges. Another feature is the 0.5-meg. resistor mounted in the negative test prod, which makes it possible to take voltage readings directly on the grids of the R.F. and I.F. tubes, whether A.V.C.-controlled or not, without upsetting the operation or tuning of the circuits. The circuit requires no special switches or resistors, the range switch I used is an old 3-point tone control switch.

Other than the small radio chassis and 0-1 ma. meter, the only parts needed are a 15,000-ohm balancing control, on-off switch, and 7 standard resistors. The choke can be the secondary of an old (even with a burned-out primary) A.F. transformer; or use a resistor. The filter is an 8-8 electrolytic, but an 8 is sufficient. If the power transformer used 2-V. volt tubes, use a 57 tube.

To put into operation, turn the balancing control to the left or least-resistance end, and turn-on the switch in the 110-V. lead. As the tube warms up, turn the balancing control to the right

to keep the meter from going off-scale backwards. Carefully adjust the meter to zero with the balancing control, and check the meter against known voltages. If the meter reads too much, reduce the plate voltage or raise the bias resistor or bleeder resistor; and vice versa.

W. T. HOLLOWELL,  
Idabel, Okla.

## SWITCH FOR VARYING "C" BIAS ON BATTERY RADIO SETS

● WHEN a set of "B" batteries has been used for some time they drop in voltage from 45 volts to about 30 volts; when this happens the "C" bias becomes too high, thus blocking the plate current of the tube so that the output is weak and distorted.

I have found that if the "C" bias can be lowered, a month or more of addi-

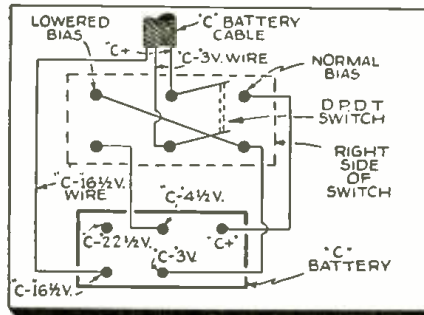

tional service can be obtained from these same batteries. The average user does not know how to accomplish this, but any Serviceman can easily do it by inserting a double-pole, double-throw toggle switch into the "C"-bias circuit so that all the radio user need do when his batteries begin to get weak is throw the switch to lower the bias. This switch is so wired that when the batteries are new and the switch is thrown to the right the entire bias is normal. (See accompanying sketch.) When the switch is thrown to the left the "C" bias is lowered.

This switch and its connections are shown in the accompanying illustration. One wire is designated "C+," another "C-3," and the other is -16½ volts. This is the Normal Bias. When the switch is thrown to the left "C+" is switched to "C-3" and the other half of the switch changes the "C-3" wire from "C-3" to "C-4½"; this arrangement automatically changes the 16½-volt bias to 13½ volts or "C-P.W.R."

This arrangement can be revised to work in any individual radio sets having different "C" bias.

JOHN MEDNANSKY,  
Kodak, So. Dakota.

## UNIVERSAL TEST SPEAKER

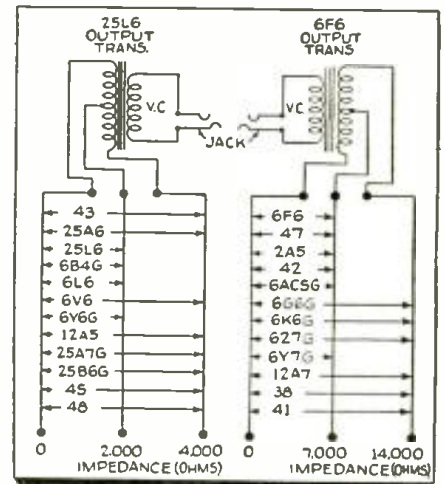

● TWO output transformers, of the type indicated in the accompanying sketch, will take care of practically all requirements for testing on the service bench, when the receiver being tested has been brought to the shop without its own speaker or when it is desired to check the speaker by comparison with the shop's test speaker. I use an At-water Kent, 10-in. dynamic, mounted on a large baffle.

A test speaker, such as a station from a Philco Phone Communicator, or a regular dynamic may be plugged into either jack, according to the tubes in the set under test.

WILLARD MOODY,  
New York, N. Y.

## SOLDERING KINK

### 電烙鐵頭保持清潔法

電烙鐵頭有時因燃燒過度，往往會發生氧化皮或鏽刀鏽過後，方能應用，惟時用鈍刀鏽之，

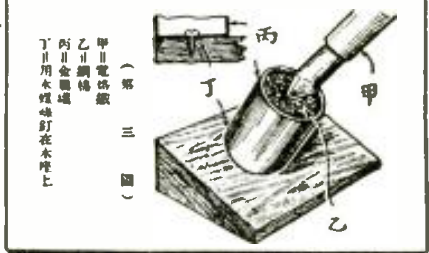

● CHINA RADIO (Shanghai), once very kindly reprinted a kink from *Radio-Craft*. We turn the tables this month and borrow the above item from our Oriental contemporary. Idea: you nail a can to a wedge of wood, fill the can with steel-wool, and use the device for keeping the soldering iron clean.

(P.S.—See *Radio & Television*, Aug. '38, pg. 219!—Editor)

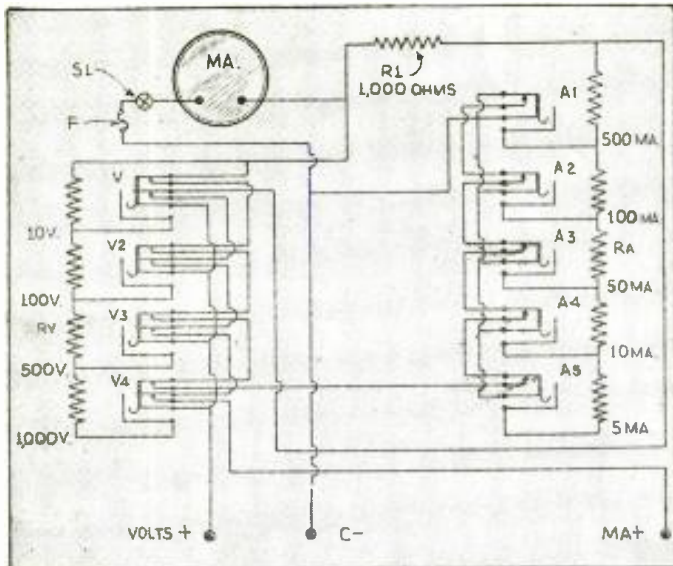

Fig. 1. Schematic diagram of the fool-proof beginners' volt-milliammeter.

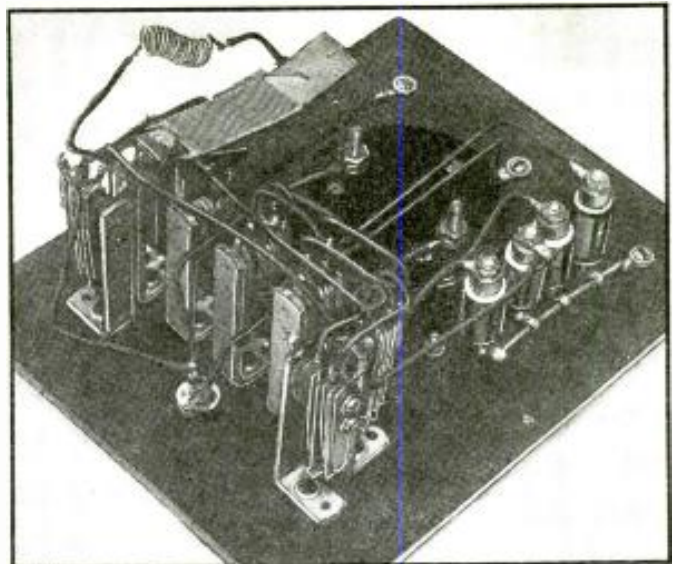

Fig. B. The inside "works" of the instrument. Two additional range jacks were subsequently added as shown in the circuit at left.

## The Beginners' Simple VOLT-MILLIAMMETER

A beginner in radio—the experimenter, the tyro Serviceman, etc.—usually finds after a short time he has been initiated into the art at considerable expense occasioned by repairs to burned out meters. With a view to reducing this mortality in test equipment the author has designed and here describes a simple, rugged meter.

**C. W. REDSTONE**  
Radio Instructor

THE radio beginner being more or less unfamiliar with meters and their use often has trouble connecting the meter into a circuit exactly according to instructions. (This is particularly true in school labs.) With this in mind the meter here illustrated was designed. It has proven to be worth the trouble in reduced upkeep.

It will, also, prove valuable to the average radio experimenter who is continually trying various circuits and making tests on them. He can feel more safe with this type of meter circuit than with the simpler arrangement of meter and multipliers or shunts. The construction of this meter looks complicated but can be made up without much trouble if care is used in the selection of parts and in following of the circuit diagram.

### CIRCUIT

In the circuit diagram in Fig. 1. Sw. 1 is a switch of the push-turn-lock type or some similar unit which will give instant or continuous contact. When the student first presses this switch to obtain a reading and sees the needle start to swing too far his natural reaction is to draw his hand away which breaks the contact and usually saves the meter from damage, especially if he has been cautioned to select a high range at the start. If the circuit re-

mains closed by locking this switch the meter fuse, F1, will protect the meter.

The various meter ranges are selected through phone jacks V1-4 or A1-5. A short-circuited phone plug inserted in one of these jacks serves to complete the meter circuit. The jacks on the voltmeter side also open two circuits when the plug is inserted, while those on the milliammeter side open one circuit. The jacks must be selected with sturdy springs and low-resistance contacts. The phone plug may be retained by the instructor until the student has completed and carefully checked the circuit connections.

One of the extra circuits on each jack is shown connected in series with all others and in the normal position they place a short-circuit across the meter element. The connecting wire must be as heavy and as short as possible in order that its shunt resistance will be as low as possible. When the range plug is inserted in any jack this short-circuit is automatically removed. Thus, the meter can not be damaged by prematurely applying power to the circuit under test.

The other extra circuit on the V jacks serves to open the line from the Ma. terminal so as to prevent burning-out of the meter or fuse by connecting up the C-Ma. terminals and placing the range plug in the voltmeter positions.



Fig. A. Photograph of the original model. Two additional range jacks, subsequently added, are included in the schematic, Fig. 1.

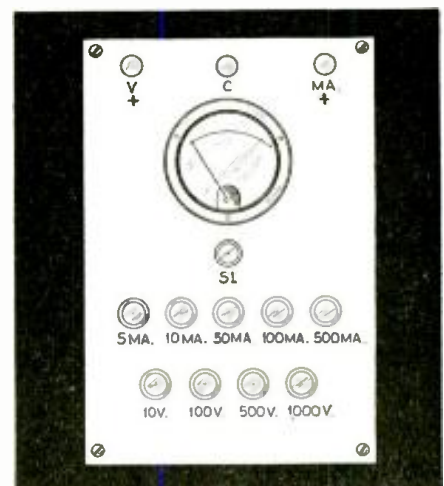

Suggested front panel layout with all meter-range jacks in place.

Connecting the voltmeter terminals to a circuit and placing the plug in an Ma. (Continued on page 767)

# OPERATING NOTES

## Trouble with . . .

### . . . PHILCO 37-650 MODEL

This set has been a source of severe headaches to several of the leading Servicemen in this state, by becoming intermittent only at times (generally the most inappropriate times). I had 2 in the shop at the same time, when I first ran into this trouble.

Each set would play fine, probably for 30 minutes, then suddenly lose about half its volume, and the shadow meter would open wide. When tuning the set, a station would blast in all of a sudden. I took out all of the waveband switches (some job) and cleaned them with carbontetrachloride, and lubricated with Russian mineral oil, using a small brush. I then replaced condenser No. 8 in schematics (40 mmf.); coupling condenser between the R.F. and 1st-det. tubes. To be sure, I put in new filter units in the A.V.C. circuits. The sets seemed to be cured.

After returning the sets to the owners, the same trouble started again, in one set in about 3 days. Putting the set back on the bench I found that strong signals caused the A.V.C. bias to go positive on strong signals. I checked the 1st I.F. transformer (even changing it temporarily) because there seemed to be a rapid fading, making the output meter bounce around, when my service oscillator was on the 6A8G grid and none of this effect, when it was emitting a 475 kc. signal on the 6K7G I.F. tube. The transformer was not the trouble. By this time I was pulling my hair.

This is the way I solved the puzzle. I

just gave the A.V.C. system more "C" bias. I shunted a 100,000-ohm resistor from the "C" bias-return on the 1st I.F. transformer to the "C"-bias source, which is a 19-ohm tap on the voltage divider resistor (No. 58 in the schematics). This perfectly solved the problem.

### . . . ZENITH 4-F-133 MODEL

If you get this set in for service there is probably one of 4 things wrong with it (if it isn't a tube): volume control, audio condenser, output transformer, or (more likely) one or both I.F. transformers. The latter complaint is the hardest to locate, because the transformers are never burned out, but upon trying to peak one you will find that it will refuse to respond. Replace this one and everything will be OK until the other goes "blooie," which practically always happens. I have never found out exactly what is wrong with them, but the reduction in resistance of the windings seems to indicate shorting in the windings.

E. D. O'NEAL,

Star Furniture Co.,  
West Union, W. Va.

### . . . PHILCO MODEL 38-2670, CODE 325

Complaint: set doesn't bring in station; all tubes and antenna, when touched with a screwdriver, give a loud click from the loudspeaker.

Symptom: wave-band switch not making contacts strong enough (sometimes the lugs will be bent, making a very poor contact).

If the set is analyzed for voltage and current it will show everything OK, even with resistance test. This condition is found

in all models of the Philco 37 and 38 series. Dismount the R-F unit and adjust the switch, and set will work like new.

### . . . PHILCO 38-2620, 38-2670, 38-650

Set operates OK if one starts tuning-in standard broadcast band and passes, in order, to higher ones. The set stops playing when brought from the upper bands (short-wave) to the lower.

Trouble: loose lugs. The movement downward allows these lugs to touch the next one, making a very puzzling short.

### . . . PHILCO 38-650

Set starts howling and giving a beautiful radio howl, when one tunes-in a shortwave station on 19 meters and 25 meters, especially the German stations.

Trouble: condenser gang vibrates, furnishing a new beat-frequency at audio rate.

After trying every trick, without sacrificing R.F. signals, we used a lower resistance value (1 meg.) for the volume control, which worked fine.

### . . . PHILCO '38'S . . . 2670 AND 2620

Complaint: very poor reception in day time, all shortwave stations received at very low volume.

Reverse the lead of the 1st I.F. transformer in the plate side of the 6A8G oscillator, solder the red wire to the plate of the tube socket and the white to the B+.

Realign the set and it will work fine.

This trick also works in some of the late '37 models.

ALEX. S. RICHARDSON,  
San Salvador,  
Central America.

## SERVICING QUESTIONS & ANSWERS

### INTERMITTENTS

(129) B. F. Mills, Great Falls, Mont.

(Q.) We have encountered a Philco Model 70-A circuit using types 24A, 27, and 45 tubes, that has a hard-to-locate trouble, as follows:

When set is jarred by walking near it or tapping chassis, a loud crackling noise issues from speaker. The sound is similar to that caused by a loose connection or loose elements in a tube. But neither can be found.

The following tests have been made without locating the trouble:

All condensers, resistors, and tubes have been replaced with new ones, except compensating condensers. Compensators have been taken apart and new mica put in.

Tuning condensers have been taken apart and cleaned.

All nuts, screws, and shields have been tightened.

All coil terminals have been checked for broken connections. Substitution has been tried on all parts except filter choke and power transformer.

Have exhausted all logical sources of finding this type of trouble that we can think of.

It is peculiar, that the trouble has no effect upon the sensitivity, volume or tone of the set. Which logically eliminates the possibility of a loose electrical connection.

This trouble is inherent with the Philco 70-A receiver, I have learned from other Servicemen in this locality.

If this trouble is common to this model, I feel sure some fellow reader has located it.

Would appreciate any help in locating

this trouble.

(A.) In your attempts to locate an intermittent-noise condition, one very common cause appears to have been overlooked. In the Philco 70-A receiver, several circuits are grounded to chassis through lugs which are held in position by tube socket rivets. Imperfect or loose rivets produce the symptoms described in your letter.

We suggest close check of these grounding lugs and all tube shield rivets.

### PENTODE PLATE GOES RED IN SPARTON SET

(130) Richard Ewald, Tiffin, Ohio.

(Q.) I would like you to tell me just what is wrong with a Sparton A.C. Model 14 superheterodyne in my shop. It consists of a transformer-coupled R.F. stage, a combination 1st-detector—oscillator, an I.F. stage, a resistance-coupled pentode power output stage, and a full-wave rectifier. The trouble with this set is that the grid of the 47 power tube gets red hot at times. There is then no reception. A slight jar however will sometimes make it run cold and play all right for quite some time; the grid voltage is normal when the tube runs cold but about double when it runs red hot.

(A.) To overcome the intermittent condition encountered on a Sparton 14 receiver, whereby the output 47 tube operates with glowing grids, requires replacement of several components.

Replace the 0.01-mf. coupling condenser to the 47 grid. Replace the 1-meg. and ½-meg. resistors in the 47 grid circuit, and the 0.1-mf. bypass condenser from junction of these resistors to chassis.

Check the speaker field for correct D.C. resistance—total 2,500 ohms with bias tap at 416 ohms.

### LACK OF ALIGNMENT

(131) S. W. Butts, Newry, S. C.

(Q.) I have a Majestic model 25, 9-tube superhet. for repair which will not align.

This set when aligned to 740 kc. will play fairly well but will not play at all above 900 kc.

When aligned to 1,300 kc. it will play almost normal but when turned back to 740 kc. the station is barely audible.

I suspected the I.F. coils and tested them. The 1st I.F. primary and secondary resistance measures about 100 ohms. The 2nd I.F. primary, about 100 ohms; secondary measures about 60 ohms.

Kindly give me what help you can.

(A.) From the symptoms described, it appears that the trouble with your Majestic model 25 receiver lies with the oscillator coil.

We suggest that this coil be replaced and the I.F. transformers peaked at 175 kc. Adjust the padder for maximum response at 600 kc., and then proceed to the high-frequency shunt trimmer to calibrate the receiver at 1,400 kc. Repeat the procedure until the dial calibration is correct.

### VOLTAGE DIVIDER OVERHEATS

(132) Henry E. Charland, Winooski, Vt.

(Q.) I have a radio set to repair which I have been unable to place in operation. It is an Airline model 62-12. The voltage

(Continued on page 747)



The address of any mentioned manufacturer will be sent on receipt of a self-addressed, stamped envelope. Mention of item number hastens reply.

# THE LATEST RADIO EQUIPMENT



Rotatable beam antenna. (1743)

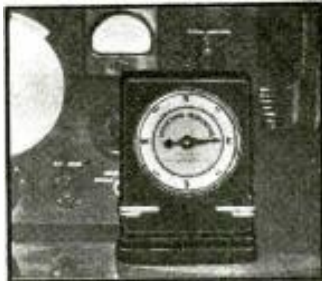

Direction indicator. (1743)



Loctal-tube set. (1744)



Pushbutton test unit. (1748)

## ROTARY BEAM ANTENNA (1743)

(Amplex Engineering, Inc.)

HERE is illustrated an actual installation, at a amateur radio station W9RS, of a new Rotary Beam Antenna and, in the second illustration at the immediate right, its indoor Direction Indicator. This is the newest aid to DX transmission and reception on 10 or 20 meters.

Entire mechanism is housed in a weatherproof aluminum alloy case which weighs only 17 lbs. Working parts consist of a powerful induction motor, with gear reduction train, that rotates 360° in one direction only. Speed of rotation is 3/4-r.p.m.

A remote Direction Indicator, geared to the antenna system, located in the operating room, affords direct-reading indication of the position of the array with respect to the points of the compass.

## TINY LOCTAL-TUBE SET (1744)

(Detrola Corp.)

THIS "model 280-U Pee-Wee, Jr.," 4-tube tuned radio frequency, A.C.-D.C. receiver measures only 6 1/4 x 4 3/4 x 4 ins. deep. High efficiency is obtained in these small dimensions, however, by the use of the new loctal-type tubes. Coils are iron-core type; speaker field is the filter choke. Tube complement: R.F., 12K7GT; detector, 12F5GT A.F., 35L6GT; rect., 35Z4GT.

Radio-Craft tested this set and reports that selectivity is adequate for the metropolitan area; and sensitivity, even on its wire-hank antenna, is ample.

## ADD-ON DISC RECORDER KIT (1745)

(Rek-O-Kut Corp.)

A RECORDING kit is now available, which may be added to any public address system or phono-radio combination, for making recordings on acetate discs. An output of 2 watts will actuate the cutter. Assembly consists of a spindle and worm gear, feed screw, and 8-ohm cutting head.

## REMOTE-CONTROLLED HIGH-FIDELITY RECEIVER (1746)

(Pacnet Engineering Corp.)

THE new Pacnet 9-tube T.R.F. High-Fidelity Radio-Phono Combination is available as (1) a complete kit, (2) a completely-wired chassis, and (3) a completely-assembled receiver. Servicemen can sell this reasonably-priced set to customers who prefer high tone quality, and armchair tuning comfort, to DX reception.

The remote R.F. tuner is a tiny unit, using 3 metal tubes, that may be fitted into a smoking stand, wall panel, etc.; its control cable extends 25 ft. to the 6-tube A.F. and Power Supply section. Output is 10 W., fed into a 12-in. P.M. dynamic reproducer; overall response is said to be flat within 10 db. from 40 to 8,000 cycles, with available treble boost of 14 db. and bass boost of 18 db. Tube complement: R.F., 2-6K7's; detector, 1-6R7; 1st stage A.F. tone-channel amplifiers, 2-6C8G's; 2nd stage A.F. amplifier, 1-6C8G; 3rd stage, A.F. power output amplifier, 2-6A3's in push-pull; rect., 1-5Z3.

## A PUSHBUTTON ANALYST (1747)

(Radio City Products Co.)

IN the model 504 Pushbutton Analyst, Servicemen have a flexible, comprehensive and speedy method for analyzing symptoms at socket terminals of radio sets, public address systems and television receivers. When used in conjunction with a Multitester it permits rapid measurements of voltage, current, capacity and resistance in all circuits.

Buttons may be locked in position if desired. Meter polarity reversal is accomplished in a second by reversing the polarity of the circuit buttons. Note that both current and voltage measurements may be made in the same circuit at the same time. Terminals carry R.M.A. numbering. The 10-wire analyzer cable includes a spare lead. Two or more buttons may be pushed simultaneously without endangering the apparatus.

## PUSHBUTTON-OPERATED C/R SUBSTITUTION BOX AND SET TESTER (1748)

(Supreme Instruments Corp.)

TOP unit, in the new pushbutton-operated, combination instrument for Servicemen, shown here, is a 9-button model 596 Substitution Box which permits setting up any of 3 values of capacity (C), of 0.1-, 0.5-, or 8 mf., for testing filter and bypass circuits; and any values of resistance (R) having maximum values of 25,000, or 50,000, ohms, or 0.1-, 0.25-, 0.5-, or 1 meg.

(Continued on page 762)



A 2-in. dynamic speaker. (1749)



Twin-light mike. (1750)

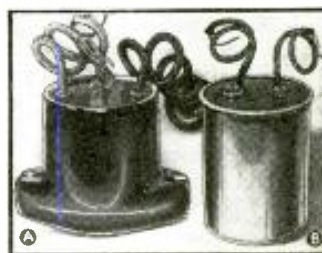

Hi-fi antenna couplers. (1751)

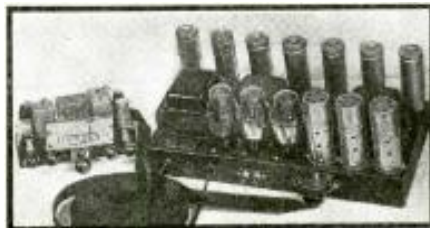
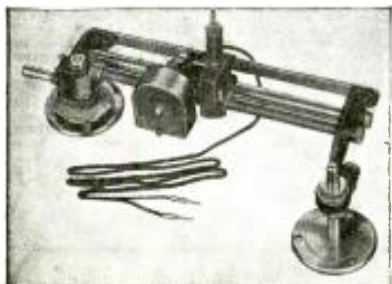

Above—Remote-control hi-fi set. (1746)

Left—Add-on disc recorder. (1745)



Pushbutton analyst. (1747)

# SUPERIOR PRESENTS 8 INSTRUMENTS

from its NEW 1939 1100!!!!!! Never before has Superior offered so much for so little! Always the Best Buy in the Instrument Field, Superior in this new 1100 series gives you even more value. We have incorporated many refinements, many new features . . . all proven to be sound and practical. We urge you to read the descriptions below carefully; see how these instruments fit your needs. Buy direct from manufacturer and save 50%.

ments, many new features . . . all proven to be sound and practical. We urge you to read the descriptions below carefully; see how these instruments fit your needs. Buy direct from manufacturer and save 50%.

**ORDER DIRECT FROM THIS AD—RUSH ORDER COUPON ON NEXT PAGE**

## THE NEW MODEL 1110-S A.C. - D.C. VOLT OHM MILLIAMMETER A Midget in Size—A Giant in Performance



Features modern 0-1 d'Arsonval type meter, precision resistors, neat etched panel housed in new striped fabricoid case.

**SPECIFICATIONS:**

|                  |                |                     |                   |
|------------------|----------------|---------------------|-------------------|
| 0-15 volts D.C.  | 0-500 ohms     | 0-500-500,000 ohms. | 0-15 volts A.C.   |
| 0-15 volts D.C.  | 0-1 ma. D.C.   |                     | 0-40 volts A.C.   |
| 0-25 volts D.C.  | 0-10 ma. D.C.  |                     | 0-75 volts A.C.   |
| 0-75 volts D.C.  | 0-100 ma. D.C. |                     | 0-200 volts A.C.  |
| 0-500 volts D.C. | 0-500 ma. D.C. |                     | 0-1200 volts A.C. |

Model 1110-S supplied complete with batteries, test leads and instructions. Size: 8½" x 5" x 3¼". Shipping weight, 5½ pounds. Our net price.....

**\$7<sup>85</sup>**

## THE NEW MODEL 1130-S

### Signal Generator with Audio Frequencies

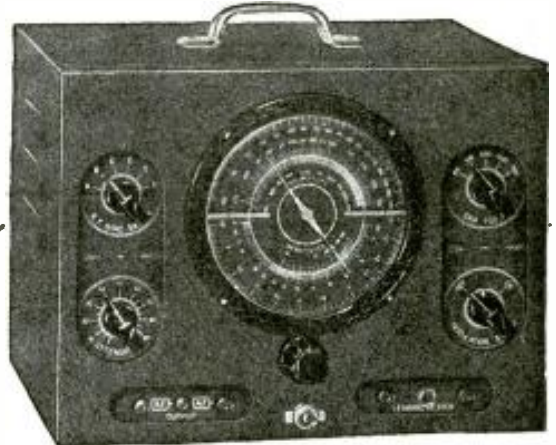

#### SPECIFICATIONS:

1. Combination R.F. and Audio Signal Generator. R.F. 100 kc. to 100 Mc., A.F.—100-7,500 cycles. All Direct reading, all by front panel switching.
2. R.F. and A.F. output independently obtainable alone or with A.F. (any frequency) modulating R.F.
3. Accuracy is within 1% on I.F. and Broadcast bands; 2% on higher frequencies.
4. Audio frequencies in 5 bands; 100, 400, 1000, 5000, and 7500 cycles.
5. Giant airplane full vision, direct-reading dial.
6. Condenser and other leakages tested to 100 megohms.
7. All services on 90-130 volts A.C. or D.C. (any frequency).

Model 1130-S comes complete with tubes, test leads, carrying handle, instructions. Size 12" x 9" x 6½". Shipping weight 15 pounds. Our net price.....

**\$11<sup>85</sup>**

## THE NEW MODEL 1150-S SUPER-ALLMETER

Featuring the New Sloping Panel



A genuine achievement! For accurate and rapid measurements. Note the following features: A.C. and D.C. Volts, A.C. and D.C. currents, Resistance. Capacity. Inductance. Decibels. Watts.

#### SPECIFICATIONS:

- D.C. Voltage: 0-15, 0-150, 0-750 volts D.C.
- A.C. Voltage: 0-15, 0-150, 0-750 volts A.C.
- D.C. Current: 0-1, 0-15, 0-150, 0-750 ma. D.C.
- A.C. Current: 0-15, 0-150, 0-750 ma. A.C.
- 2 Resistance Ranges: 0-500 ohms to 200 mfd.
- High and Low Capacity Scales: .0005 to 1 mfd. and .05 to 200 mfd.
- 3 Decibel Ranges: -10 to +19, -10 to +38, -10 to +53. Inductance: 1 to 700 Henries Watts

Based on 6 mw. at 0 D.B. in 500 ohms. .006000 to 600 Utilizes new 4½" square 0-1 d'Arsonval type meter with precision resistors housed in our newly devised sloping case for rapid and accurate servicing.

Model 1150-S supplied complete with test leads, tabular charts and instructions. Size 10" x 7¼" x 4¼", shipping weight 9 pounds. Our net price..... Portable carrying cover, 75c additional.

**\$11<sup>85</sup>**

## THE NEW MODEL 1180-S SET TESTER

A Complete Laboratory All in One Unit!

Featuring Our New Type Sloping Panel for Precise and Rapid Servicing



A complete testing laboratory all in one unit! Combines Superior models 1140-S and 1150-S. For specifications read the description of both these models herewith. Comes housed in sturdy, black case with sloping panel for rapid and simple measurements. Complete with test leads, tabular charts, instructions and tabular data for every known receiving type tube, including many transmitting types. Size 13¼" x 9¼" x 5". Shipping weight 18 pounds. Our net price..... For Portable Cover, add 95c.

**\$17<sup>85</sup>**

## THE NEW MODEL 1140-S TUBE TESTER



A really modern tube tester conforming to all standards of good engineering practice. Utilizes a 3" d'Arsonval type meter with calibrated scale. Furnished in a sturdy black case with sloping panel for easy operation. Removable cover and carrying handle for either portable or counter use.

#### SPECIFICATIONS:

1. Tests all 4, 5, 6, 7, 7L, octal, and loctal base tubes, including diodes.
2. Tests by the well-established emission method for tube quality, directly read on the GOOD? BAD scale of the meter.
3. Affords separate neon test for leakage and shorts between elements.
4. All services performed by the use of only five controls at maximum, and many tests do not require working all the controls.
5. Supplied with instructions and reference table so that the filament voltage and emission measuring controls may be properly set for the enumerated long list of tubes, which includes all tubes commonly encountered in servicing.
6. Works on 90-120 volts A.C. 60 cycle.

Model 1140-S comes complete with instructions and tabular data for every known receiving type of tube as well as many transmitting types. Shipping weight 10 pounds, size 10" x 7¼" x 4¼". Our net price..... Portable Cover, 75c additional.

**\$10<sup>85</sup>**

# SUPERIOR INSTRUMENTS CO.

136 Liberty St., RC-6  
NEW YORK, N. Y.

RUSH ORDER COUPON ON NEXT PAGE

Please Say That You Saw It in RADIO-CRAFT

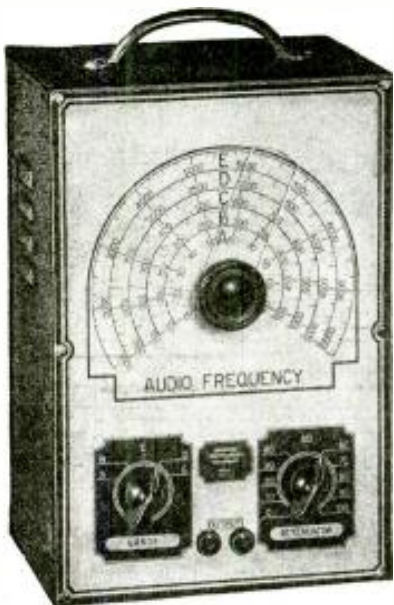

**THE NEW  
1190-S AUDIO  
OSCILLATOR**

*Continuously  
variable from  
0-10,000  
cycles*

1. Checks distortion in P. A. systems and audio amplifiers.
2. For checking Sweep voltage in television receivers and transmitters.
3. Frequency checks for the hard of hearing persons and for the use of hearing aids.
4. Centralizing trouble in audio circuits in receivers and P. A. amplifiers.
5. A. C. source for Wheatstone and Universal bridges.
6. Checks frequency response in P. A. systems for use in recordings.
7. For checking frequency responses of microphones and speakers.

**SPECIFICATIONS:**

1. Direct reading in frequencies 0-10,000 cycles in 5 bands, all fundamentals, by front panel switching. 2. Continuously variable from 0-10,000 cycles, with 35 inches of calibrations etched on front panel. 3. Operates on 90-120 volts A.C. or D.C., any frequency. 4. Utilizes 3 tubes—one oscillator, one rectifier and one amplifier tube. 5. Positive attenuation from 0-2 volts maximum. 6. No dead spots. 7. Housed in beautiful black wrinkle finish shielded cabinet, with etched aluminum panel and carrying handle.

Model 1190-S, complete with tubes, leads and instructions. Shipping weight 8 pounds. Our net price.....

**\$885**

**THE NEW MODEL 1175-S  
FREE POINT ANALYZER UNIT**

*Complete with portable carrying case and cover*

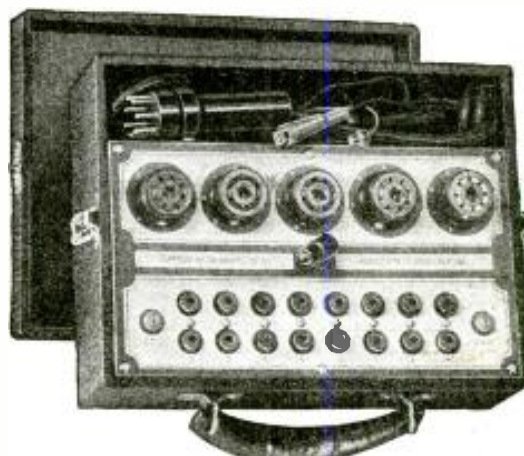

May be used with any multimeter or set tester for testing by the point-to-point method of isolating and locating trouble.

**SPECIFICATIONS:**

1. Enables you to test tubes by the plate current method when used in conjunction with any multimeter. 2. Rapid current measurements under actual operating conditions without opening circuit for meter insertion. 3. Enables you to locate defects in any particular stage without removing chassis from cabinet. 4. Permits rapid and precise voltage and resistance measurements between any two points in a radio receiver, terminating at a tube socket. 5. Standard R.M.S. numbered tube chart for quick identification of tube elements. 6. Sockets are all R.M.S. coded. Complete with six slip-proof adaptors, slip-proof type analyzer plug, dual insulated grid caps. 7. Etched aluminum panel, housed in leatherette covered portable type cabinet, cover included.

Model 1175-S complete in carrying case and cover, with all accessories included, all necessary adaptors, plug, R.M.S. coded tube base chart and instructions. Shipping weight 7 pounds. Our net price.....

**\$885**

**SUPERIOR ANNOUNCES  
FOR THE FIRST TIME!!!!**

**THE NEW  
Giant 9"  
X-RAYOMETER**

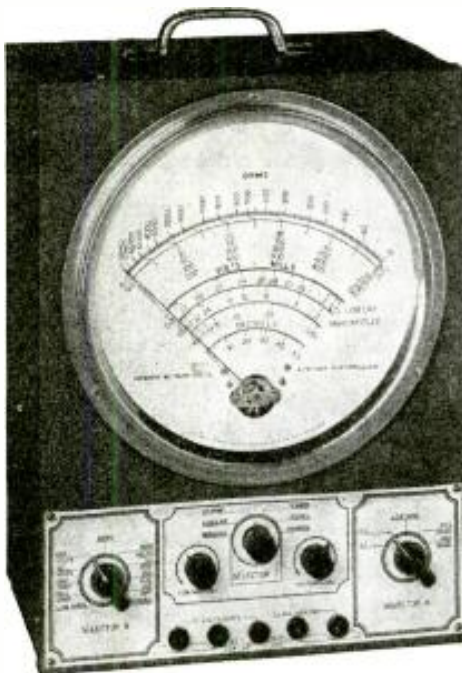

Even the serviceman who through past purchases knows that he can always get MORE instrument for LESS money when purchasing the SUPERIOR WAY, will be amazed when he reads the record breaking specifications of the X-RAYOMETER, and then notes the unbelievably low price. The X-RAYOMETER features 9" d'Arsonval type meter. BUILT-IN POWER SUPPLY ENABLES RESISTANCE MEASUREMENTS UP TO

**30 MEGOHMS  
(NO EXTERNAL BATTERIES OR POWER SUPPLY)**

1/2 OHM EASILY READ ON LOW OHM SCALE.  
D.C. VOLTAGES UP TO 2500 VOLTS  
A.C. VOLTAGES UP TO 1000 VOLTS.  
D.C. CURRENTS UP TO 25 AMPERES.

2 capacity ranges. Micas, papers, electrolytics read up to 50 Mfd., 2% accuracy. PERCENTAGE OF LEAKAGE of electrolytics read DIRECTLY on scale. Insulation, inter-elements and all other leakages directly read up to 30 megohms.  
4 output ranges up to 1000 volts.  
2 inductance ranges up to 703 henries.  
3 decibel ranges.  
Highly polished etched aluminum panel.

**SPECIFICATIONS:**

Resistance measurements in three ranges: 0-1000 ohms, 0-100,000 ohms, 0-30 megohms  
D.C. Voltage measurements in five ranges: at 1000 ohms per Volt, 0.50/0-250/0-500/0-1000/0-2500 Volts. Television and other high voltage power supply circuits easily measured.  
A.C. Voltage measurements in four ranges: 0-50/0-250/0-500/0-1000 Volts.  
D.C. current measurements in five ranges: 0-50/0-250/1 Amp./10 Amps./25 Amps. High current ranges suitable for automotive and industrial work.  
Capacity directly read on meter scale in two ranges: .005-1 Mfd./2 Mfd.-50 Mfd.  
Percentage leakage of electrolytic condensers directly read on meter scales. Actual condition of condenser quickly determined.  
Insulation, inter-element and A.V.C. leakages directly read on meter scale up to 30 megohms.  
Output measurements in 4 ranges: 0-50/0-250/0-500/0-1000 Volts. Built-in blocking condensers enables rapid alignment of radio equipment.  
Inductance measurements in two ranges: 1-7 Henries/7-703 Henries.  
Decibel measurements in three ranges: Db. based on 6 M.W. at 500 ohms.-10 + 20/-10 + 13/-10 + 40. Radio frequency measurements in both radio and P.A. amplifiers.

X-RAYOMETER comes housed in a new army grey crystalline, heavy-gauge cabinet. Complete with test leads and instructions. Size 13 3/8" x 10" x 6". Shipping weight 20 pounds. Our net price.....

**\$1795**

RC-6

**RUSH ORDER  
COUPON**

Mail To—  
SUPERIOR INSTRUMENT CO.  
136 Liberty St.  
New York, N. Y.

Fill in

NAME .....

ADDRESS .....

CITY ..... STATE .....

| MODEL                      |             | AMOUNT |  |
|----------------------------|-------------|--------|--|
| <input type="checkbox"/>   | 1110-S      |        |  |
| <input type="checkbox"/>   | 1130-S      |        |  |
| * <input type="checkbox"/> | 1140-S      |        |  |
| * <input type="checkbox"/> | 1150-S      |        |  |
| * <input type="checkbox"/> | 1180-S      |        |  |
| <input type="checkbox"/>   | 1190-S      |        |  |
| <input type="checkbox"/>   | 1175-S      |        |  |
| <input type="checkbox"/>   | X-Rayometer |        |  |
| <b>TOTAL</b>               |             |        |  |

\*1140-S Cover 75c Additional  
\*1150-S Cover 75c Additional  
\*1180-S Cover 95c Additional  
Amount enclosed

\$ .....

Paid in Full  
 Part Paid—Balance C.O.D.  
(25% deposit required on C.O.D. shipments.)

Please Say That You Saw It in RADIO-CRAFT



All the worthwhile  
Radio Trade News  
of the past Month—  
Digested for busy  
radio men.

# RADIO Trade Digest

A PLEDGE: — To  
print the important  
news of the radio  
industry; to review  
major news events;  
to help point a path  
to radio profits.

IMPORTANT HAPPENINGS OF THE MONTH IN THE RADIO INDUSTRY

No. 10

JUNE, 1939

No. 10

## BUSINESS PREPARING FOR BOOM AS TELEVISION MAKES ITS BOW

*Rush of Activity, with Stations Filing Applications, New  
Service Instruments Provided, British Experts  
Brought to U. S., and Dealers Enthusiastic*

Amer. Tel. Corp.'s demonstration of television to bring a close-up of an operation in a Brooklyn hospital to student doctors in another part of the building was successful, according to the RTD reporter, who looked into a Kinet (remote c-r tube) and saw a hernia being jacked up.

Farnsworth Tel. & Radio Corp. is moving to the Capehart plant in Ft. Wayne, Ind., which it acquired.

WOR (Newark), WLW (Cincinnati), and WGN (Chicago), got together and formed the first Facsimile Network.

Francis H. Engel is RCA's new Television Coordinator (whatever that is).

### Dealers Boom Telly

Ken Cramer, of Allen B. Du Mont Labs., says dealer enthusiasm for telly boomed even before regular programs went on the air.

Least-technical-reporter of RTD has been assigned job of putting together an FADAndrea telly kit, and will report his findings for this department to give dealers and Servicemen the lowdown on what reactions will be when customers try the same task.

Bloomingdale's (New York department store) will not only use ATC kinets to show fashions, etc., in various departments, but will peddle the company's sets, too, at \$125 to \$395. ATC  
(Continued on page 760)

## NAB Will Help Solons Write New Radio Law

Neville Miller, President of the National Association of Broadcasters, offered the broadcasting industry's full cooperation in helping rewrite the federal radio law, recommended recently by Pres. Roosevelt.

"The President, in recommending that Congress lay down radio policies in new legislation 'so clear that the new administrative body will have no difficulty in interpreting them or administering them', has put his finger on the core of the radio problem," said Mr. Miller.

## STAR SALESMAN WINS AWARD

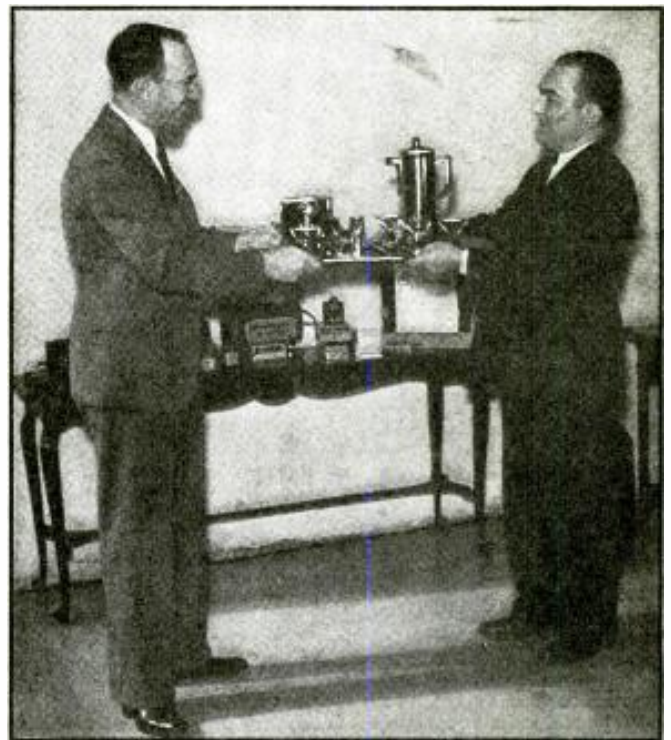

Walter Marsh, sales mgr. of Meissner Mfg. Co., Mt. Carmel, Ill., presents a chrome & silver cocktail set to J. Earl Smith, winner of the 1938 sales contest. Smitty obtained the highest percentage of his sales quota. The 2 men just returned from a successful trip through La. & Tex. Other Meissner news is that John O. Olsen has taken over the Erie, Pa., territory, & that Harry B. Segar has added northern N. Y. state to his beat.

## PORTABLE TELLY TRANSMITTER

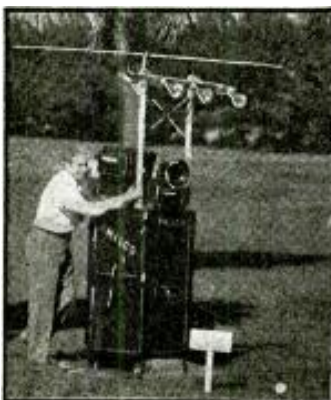

New Philco television xmt, being used to televise golfer at Palm Beach, Fla., is complete with lights 'n' everything. Image was picked up on receivers 150 ft. away. (Note cameraman butting into telly pick-up's range—you can't avoid 'em anywhere!)





# AN EDITORIAL

By Artie Dee

It isn't often you can get an extra reward for going after business—but you can right now!

Usually you put on a business drive with the intention of earning money, your legitimate profit from your enterprise. If you can make a fair profit, that is all you expect.

But now *Radio-Craft* is offering you an extra incentive to get busy. Your industry in the Public Address installation field may win you a portion of \$4,000 worth of equipment. Isn't that worth going after?

It all comes back to one well-known fact. *There is always business to be had, for the men who will go after it.* *Radio-Craft* wants its readers to be the liveliest bunch of Servicemen in the country. Therefore, it has arranged this method of stimulating them.

If you enter the Contest, you may win one of the 4 monthly 1st Prizes, worth approximately \$250 each. Or you may win one of nearly 100 other prizes. But no matter whether you win a prize or not, *you cannot lose!*

Every Serviceman who enters the Contest is sure to find himself better off financially than if he had stayed out. The reason is that he will have to do some installation work in order to qualify. And if he doesn't make a profit on that work, he's crazy.

Even if you do not enter the Contest, you will profit from it, whether you are actually doing any public address installation work right now or not.

The winning entries in the contest will point the way to larger profits in this type of work. Although you may be a dealer who has never handled a P.A. job, you will be shown how to engage in this highly profitable specialty—a branch of radio which is growing in



Though *NBC* said telly broadcasts would likely be limited to 2 hrs. *per wk.*, this dept. has learned that programs will run from 3 to 5 hrs. *per DAY!* . . . A good part of this will be movie film & direct pick-ups from the Fair . . . *CBS* should follow right behind.

*Censorship of bestg? Don't be sill! FCCommish McNinch told Snoops & Scoops, "I'll follow Voltaire. Though what they say may be abhorrent to me, I will defend their right to say it." And he was talking about a certain Stormy Petrel when he made the remark. (Tell you who, but it was off'n the record.)*

Ooops! Even the *Daily News* pulls bobbles. It told its 1 3/4 million readers how it had gummied up a story on *Int. Carrier-Call & Television Co.* The original story—the mistaken one—had *I.C.-C. & T.* in trouble; the truth was that they are suing *RCA* for alleged infringement of Patent No. 2,114,718.

*In that WMCA re-organization, Donald S. Shaw became Gen. Mgr. & V-P in charge of sales, with Charles Stark as Sales Mgr. . . . If you're handling cameras as a side-line, get a load of Foto-Craft (also edited by Hugo Gernsback) . . . New Sprague PTM 450-volt cardboard dry electrolytics have universal metal tabs for quicker mounting.*

*Crosley Corp.* is putting out facsy in kit form at \$39.50—a swell buy for tinkerers who like mechanix as well as

importance every year.

If you have not entered the public address field, you are passing up a mighty good opportunity to make money. If you are in, give some more thought to selling.

At all events, get into this great new Contest. You have nothing to lose and everything to gain!

## 5-10 METER CONVERTER

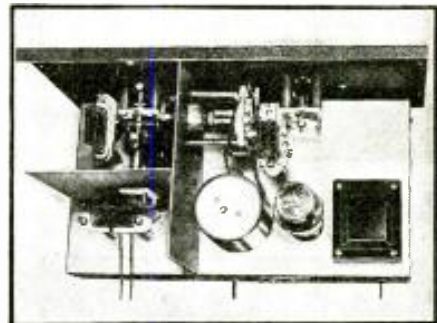

Wholesale Radio Service Co., N.Y.C., has a new 5-10 m. converter kit designed by Frank Lester (W2AMJ) to work with any receiver above standard bcst band. It's for telly sound, primarily. (Wholesale kindly helped *Radio-Craft* in telly-sound converter experiments, several months ago.—Ed.)

electronix. . . And *W. H. G. Finch* has made arrangements to spray *INS* (Hearst) news out from the *W2XBF* facsy towers. . . Have you heard the honey of a Quiz on *WSB*, Atlanta, Ga., at 9:30 P.M. Mondays?

(Continued on page 759)

## BIZ OPS

*There's business for those who will take the trouble to go after it. Perhaps YOU can get this business! It's worth while!*

*Nic H. Mannsdorff, Ltd., Helsingfors, Finland, writes: "We are import agents and are ready to take more agencies for Finland. We have the best connections and can make good turnover if prices and articles are suitable for our market."*

*"I have opened a Radio Shop and would like to have my name put on a mailing list of any Radio Parts Mfg.," writes Acme Radio Service, 12404 Klinger Ave., Detroit, Mich.*

## TWO RISE AT IRC—TWO MORE AT RCA



HARRY EHLE, sales mgr. of International Resistance Co., Phila., adds job of Asst. to the Pres. to his present duties.



JESSE MARSTEN, chief engineer of IRC for many years, has just been made a Vice-Pres., says co.'s President, Ernest Searing.



W. L. ROTHENBERGER, mgr. of RCA's Commercial Products Division, manages the enlarged Commercial Sound Products Dept.



GEORGE EWALD, former RCA District Mgr. in Dallas, Tex., becomes sales mgr. of the Commercial Sound Prods. Division.

PORTABLES FOR PUBLICITY



175 RCA-Victor portables were sent to executives all over U.S. by Frederick Drake, of Harper's Bazaar, to publicize Paris fashion bcst. Here he gives instructions to messengers in N.Y.C.

SELL TO SPORTSMEN



Sales of portables to sportsmen was motive for Terminal Radio Corp.'s exhibit at Natl. Sportsmen's Show. Over 250,000 saw latest Fada, Philco, RCA-Victor, Emerson, Sentinel & Espey sets.

NEW BATTERY LINE



Long a leader in the storage battery field, Philco has entered the dry battery market with a line of 25 types from pen-light to radio "A". C. E. Carpenter is in charge of activities.

\$'s & N<sup>o</sup>. 's Dept.

"The difference between us, Mr. Goldwyn, is that you care nothing about money, while I care nothing about Art"—attributed to George B. Shaw, playwright.

ENCOURAGING sign was increase of excise tax on radio in Jan.—57% over Dec.!!! They were about as much greater than those of Jan. '38, too! Biz of approx. \$11,500,000 was indicated for the preceding mo.! Looks like that corner had been turned ! ! ! !

EXPORTS DIPPED, however, but only 9.7% from Jan. '38. Much of this drop was attributed to virtual closing of Argentine market. Total exports for Jan. '39 were \$1,466,875. Breakdown for '39 shows:—

|              |           |
|--------------|-----------|
| Sets         | \$408,842 |
| Sets (#)     | 35,081    |
| Tubes        | \$156,355 |
| Tubes (#)    | 380,928   |
| Parts, etc.  | \$296,760 |
| Speakers     | \$38,693  |
| Speakers (#) | 24,282    |
| Xmtrs        | \$165,225 |

(Continued on page 760)

Sales Helps and Deals

New Paths to More Business

RCA has 3 window display units lithoed in 8 colors, to push RCA-Victor, RCA-Radiotron, & Cunningham tubes. Nipper & recording stars are featured. Special streamer boosts servicing. Baseball & football skeds for consumer distribution are also available.

To boost tube sales, there's a green, black and white streamer 3 3/4 x 24 inches, to be used as a window sticker. It says, "We Recommend SYLVANIA—the set-tested RADIO TUBE." (Can you guess what manufacturer puts it out?)

NATIONAL UNION is continuing the Precision Instrument offer with sales of tubes and/or condensers. They're also going heavier on the electric clock sign offer described in this section last month.—\$5 without or \$6 with dealer's name.

(Continued on page 760)

Personal

COL. JOHN L. BUCHANAN, long an executive of G-E, and coordinator of the co.'s World's Fair activities, died in the Greenwich (Conn.) Hospital, at the age of 55. He is survived by his wife, his mother, and two children.

L. L. KELSEY, sales mgr. of Stewart-Warner's radio division, took a 3-wks. tour to meet west coast dealers.

CHARLES I. ROBBINS, foreign sales rep. for Arcturus tubes, is making a 20,000 mile, 3-mo. tour of South America, after having returned from a 4-mo. tour of Europe.

G. S. ALCORN has become sales mgr. of the wiring device section of G-E's appliance & merchandise dept.

E. W. BEYER has been made assistant in the radio dept. of Crosley Corp.'s export division.

E. R. SCHAEFFER, formerly supervisor (Continued on page 760)

Parts Show Reservations Larger Than Last Year's

More than 100 manufacturers have contracted for over 130 booths in the National Radio Parts Show at the Stevens Hotel, Chicago, June 14-17, sponsored jointly by RMA and the Sales Managers Clubs. The number of exhibitors, as well as the space contracted for, is ahead of last year's record.

The RMA convention will open Tuesday, June 13, and the Parts Show on the following day. "Jobbers' Days" will be observed at the Parts Show on Wednesday and Thursday, with the Show closing at 6:00 P.M. so that manufacturers and jobbers may attend the annual RMA banquet on Wednesday evening, June 14. On Friday, June 16, and Saturday, June 17, the Show will be open to the general trade, with the Servicemen carrying on their principal activities on Friday, and radio amateurs on Saturday. This is the first time in the history of the radio shows that specific days have been set aside for various sections of the radio parts industry.

OFF THE PRESS

Latest Publications to Keep You Informed

SPRING & SUMMER CATALOG No. 76. Wholesale Radio Service Co., N.Y.C., Chicago, Atlanta, Boston, Newark, etc. 188 pp. Best catalog this co. has had yet—& they've had some honeys. Almost 60 models of sets; 24 pp. of Lafayette P-A equip't; 88 pp. of parts & service equip't; 40 pp. of cameras & photo supplies. Some real bargains!

IRC VOLUME CONTROL GUIDE. International Resistance Co., Phila., Pa. 124 pp. The most complete data on volume controls & resistors this reviewer has ever seen. Data that every Serviceman should have.

RCA INSTITUTES CATALOG No. 3902. RCA Institutes, Inc., N.Y.C. & Chicago. 48 pp. Data on schools & courses—including television.

JOBBERS' BULLETINS. Crowe Nameplate & Mfg. Co., Chicago, #0-37; auto-radio fittings & controls. #0-36; auto-radio remote controls. #75; dial plates, dials, knobs, etc. #226; Delco panel kits for leading makes of cars. #227; same, but for Arvin auto-radios. #228; same, but for Philco auto radios.

(Continued on page 760)

Changes & New Addresses

Where to Reach Old and New Companies

Industrial Instruments, Inc., new co. at 162 W. 23 St., Bayonne, N. J. Pres. & chief engineer is Nathan Schnoll, former chief engineer of Solar; Sales mgr. is Sylvan A. Wolin. Co. is producing conductivity bridges, insulation testers, & automatically-controlled distilled water testers.

Aerovox Corp., 347 Fifth Ave., N.Y.C., is where to reach that co.'s new N.Y. sales office.

Mark G. Mueller, Ward-Leonard rep. for Colo., western Neb., northern N. Mex. & nearly all Wyo., has moved to 1644 Blake St., Denver, Colo.

New Stewart-Warner reps.:—David Kaufmann's Sons, Baltimore, Md. Appliances, Inc., Cincinnati, Ohio. Household Appliance Corp., New Orleans, La.



## RCA VICTOR ("LITTLE NIPPER—THE 2ND") MODELS 9TX-1, 9TX-2, 9TX-3, 9TX-4, 9TX-5

5-Tube Superhet.; Broadcast Band Only (Range, 530 to 1,720kc.); A.C.-D.C. Operation; Power Output (Max.) 2 W.; Power Consumption, 50 W.; A.V.C.; "Single-Ended" Tubes.

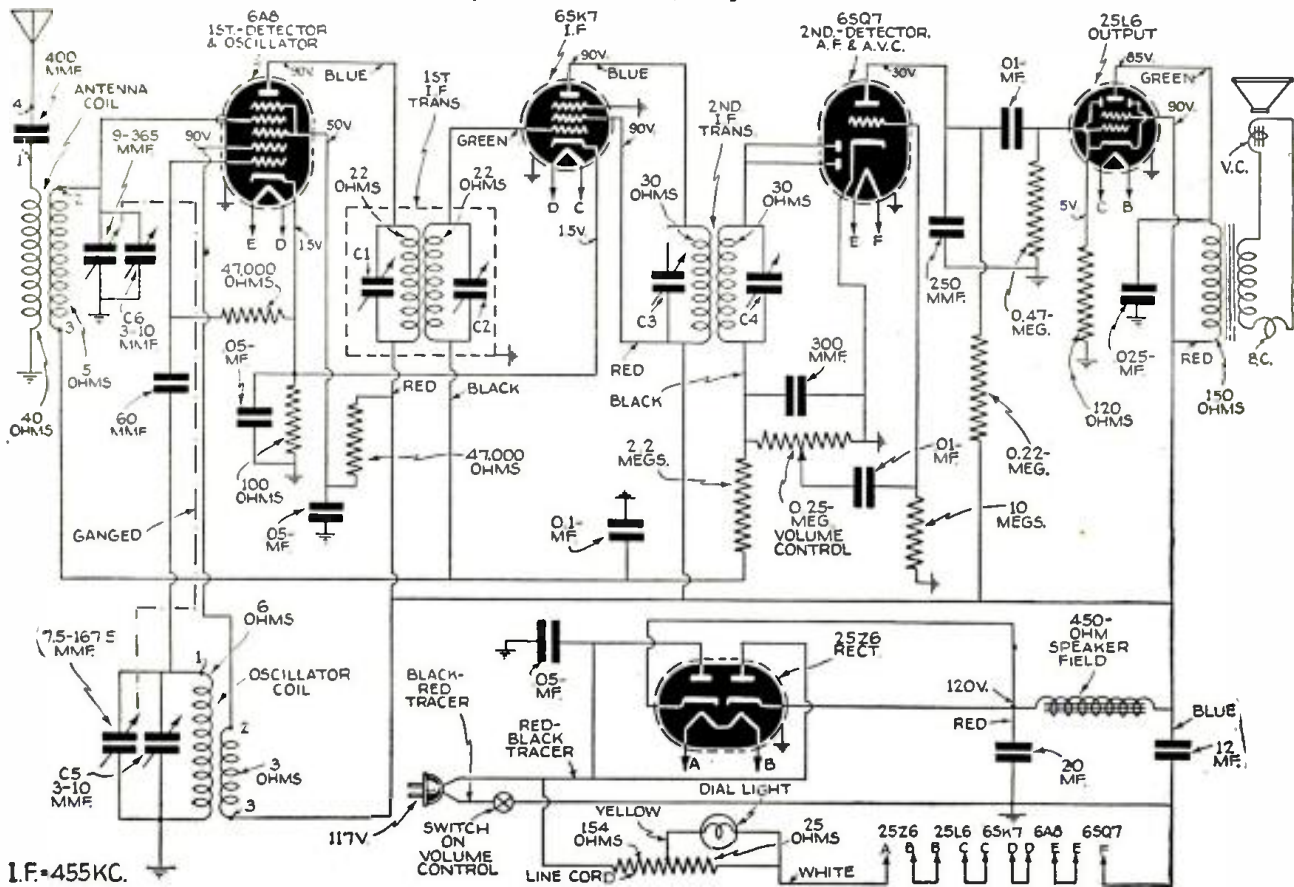

I.F.=455KC.

Schematic diagram and operating voltages of the RCA Victor model 9TX series of receivers known as "Little Nipper the 2nd."

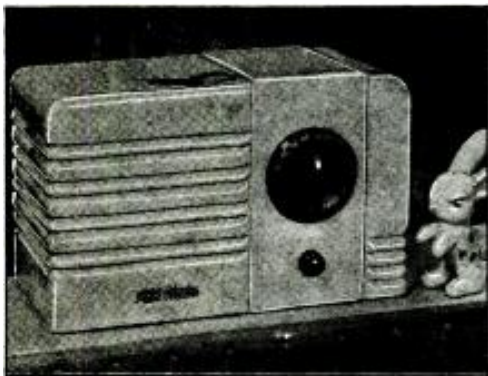

RCA Victor model 9TX-4, one of the series of new small sets, measures 5 1/2 ins. high, 8 1/2 ins. wide and 4 1/2 ins. deep. Uses new "single-ended" tubes.

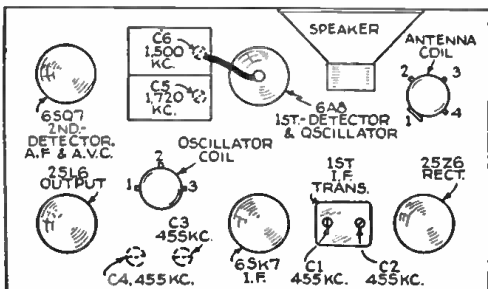

Diagram showing locations of tubes and aligning trimmers.

### PRECAUTIONARY LEAD DRESS

1. Dress 1st I.F. plate and grid leads against chassis and away from each other. Dress plate lead from 6SK7 close to chassis.
2. Dress electrolytic condenser against rear apron.
3. Keep leads away from adjusting screws to allow easy access.
4. Dress output plate lead along front apron and away from 6A8.
5. Dress parts at ends of chassis to clear cabinet bosses.

### ALIGNMENT

**Output Meter Alignment**—Connect the meter across the voice coil, and turn the receiver volume control to maximum.

**Test-Oscillator**—Connect the low side of the test-oscillator to the receiver chassis, through a 0.01-mf. condenser, and keep the output as low as possible.

| Steps | Connect the high side of test-oscillator to—         | Tune test-osc. to— | Turn radio dial to—                  | Adjust the following for max. peak output—     |
|-------|--|--------------------|--------------------------------------|--|
| 1     | 6A8 1st-Det. grid cap. in series with 0.01-mf.       | 455 kc.            | Quiet point at 1,600 kc. end of dial | C1, C2, C3, C4 (1st and 2nd I.F. transformers) |
| 2     | Antenna term. of ant. trans. in series with 100 mmf. | 1,720 kc.          | Full clockwise                       | C5 (oscillator)                                |
| 3     |  | 1,500 kc.          | Resonance on 1,500 kc. signal        | C6 (antenna)                                   |

### MISCELLANEOUS

**Power-Supply Polarity**—For operation on D.C., the power plug must be inserted in the outlet for correct polarity. If the set does not function, reverse the plug. On A.C., reversal of the plug may reduce hum.

**Resistor in Power Cord**—The power cord contains a resistor which becomes warm during operation.

**Antenna**—The set is equipped with length of antenna wire. Do not connect the antenna to ground. If an outdoor antenna is used, it should not be longer than 100 feet, including lead-in. If it is longer, connect a 100 to 200 mmf. condenser in series with the lead-in.



# THREE EXTRA SALESMEN...

## TO BRING YOU EXTRA PROFITS

### MR. ARCTURUS TUBE MAKES FRIENDS AND KEEPS 'EM!

The husky chap that everyone likes! High quality ARCTURUS TUBES in your customers' sets keep 'em happy—they'll call the man who recommended "those good tubes" the next time they need service!

### MR. ARCTURUS \* EQUIPMENT DEAL GIVES YOU MODERN EQUIPMENT!

The "Santa Claus" of the family brings you EXTRA PROFITS in the form of valuable modern shop and store equipment! The ARCTURUS EQUIPMENT DEAL offers you Lower Down Payments, Low Tube Requirements, Standard Tube Prices, Immediate Delivery of the equipment you select!

### MR. ARCTURUS DEALER HELPS BRINGS IN NEW CUSTOMERS!

Depend on this one to keep the place "humming"! Tested merchandising material to attract new customers and bring the old ones back again and again!

**GET ACQUAINTED**  
with the three Arcturus Boys—cash in on Radio's finest and fairest Equipment Deal... "Go Arcturus" for Extra Profit! Just mail the coupon, we'll do the rest!

(\*Offer good in U.S.A. only.)

# ARCTURUS

ARCTURUS RADIO TUBE CO., Newark, N. J. C-19  
Without cost or obligation, send my copy of the  
ARCTURUS DEALER HELPS Folder and details of  
the ARCTURUS EQUIPMENT DEAL.

Name.....

Street.....

City.....State.....

I am a dealer  I am a serviceman. My

jobber is.....

For your convenience this coupon can be posted on a penny postcard

## SEE! HEAR!—AMERICAN TELECEIVERS FOR 1939

(Continued from page 723)

16 5/16 x 9 3/4 x 19 1/2 ins. deep. The price of this attachment is in the \$175-200 range. The remaining 3 set models, described below, are in the \$200-600 range.

The model TRK-5 is a console, also with a 5-in. kinescope. It has 24 tubes, plus kinescope, and incorporates electric tuning in the 8-tube, all-wave radio chassis. Impressive, modern-style cabinet is built of brilliant woods, skilfully finished. Size: 43 3/4 ins. high, 29 3/4 ins. wide and 18 13/16 ins. deep.

The model TRK-9 RCA Victor television receiver has a 9-in. kinescope, reproducing images 5 1/2 by 7 1/4 ins. for direct viewing from in front of cabinet. It employs 36 tubes (including a 12-tube, 3-band all-wave radio chassis and switch for victrola attachment), and the kinescope. Measures 47 1/4 ins. high, 31 1/2 ins. wide and 24 3/16 ins. deep.

The RCA model TRK-12 television receiver is the most comprehensive job in the entire line. It utilizes 36 tubes in addition to the cathode-ray receiving tube. It has a 12-in. kinescope which reproduces an image 7 3/4 by 9 3/4 ins. on a mirror on the underside of the raised lid for indirect viewing. Reproduces images in unusually fine detail. Electric tuning for sound reception is provided for 9 stations. Cabinet is of fine matched woods, and measures 40 1/2 ins. high, 34 3/4 ins. wide and 19 3/4 ins. deep.

*Du MONT.* Newest development in the television receiver line of Allen B. DuMont Labs., Inc., is the "orchestra seat" model illustrated on pg. 723. The cathode-ray tube is mounted in an inclined position so that its front face is tilted upwards. Thus both the nearby sitter or the person standing some distance away can view the image to best advantage. This low-console sight and sound receiver is equipped with a 14-in. cathode-ray receiving tube capable of presenting a sharp, brilliant 8- x 10-in. image comparable in quality to 16-millimeter film projection. The low-console model receiver lists for \$445.

A high-console receiver model is available at the same price.

A table model, also using the 14-in. cathode-ray tube (and also 22 other tubes mounted in double-deck chassis), lists for \$395.

*GENERAL ELECTRIC.* Five television receiver models, ranging from an image receiver with sound converter to consoles combining television and all-wave radio, have been announced for spring production by the General Electric radio and television division, Bridgeport, Conn.

Smallest set—the one illustrated on pg. 723—in the line is the HM-171, a table-type image receiver with sound converter. It can be used to receive television images without sound, or can be used in conjunction with special types of radio receivers which will be made available later. The table model employs a 5-in. image tube, included in the complement of 17 tubes. The set measures 14 1/2 x 20 x 19 ins. deep.

Model HM-185 is a console-type television receiver for both sight and sound, also employing a 5-in. image tube. It has 18 tubes in all, has average high-fidelity audio, and is 38 ins. high, 23 ins. wide, and approx. 18 ins. deep. Controls are similar to those on the smaller set with the addition of volume and tone control.

Model HM-225 is a console-type television receiver for sight and sound employing 22 tubes, including a 9-in. image tube. It has 2 chassis—video-sound and power, and high-fidelity audio. This model is slightly larger than the HM-185, and controls are similar.

The 2 remaining console models, the HM-226 and the HM-275, combine all-wave radio and television receiver features. The former employs 29 tubes and the latter 30 tubes, including a 12-in. image tube. Each has a video-sound, power, and radio chassis.

Approximate price range of the new television receivers is from \$250 to \$1,000.

*WESTINGHOUSE.* The Spring line of television receivers just announced by Westinghouse Electric Supply Company includes 4 models of which the WRT-700, illustrated on pg. 723, is representative.

It has unusual interest however in view of the fact that the WRT-700 is a television attachment called the *televisor* which connects to an external radio receiver for the associated sound portion of the television equipment. The image is set up on the end of the 5-in. kinescope in the table-model televisor while the sound portion of the program is filtered out and transferred by means of a converter to an associated radio receiver. This latter feature makes television reception available at minimum cost. Price of WRT-700, \$199.50.

The de luxe televisor WRT-703 consists of a 12-tube, 3-band radio and television receiver with 12-in. kinescope housed in a specially-designed cabinet of selected woods. All controls are concealed by the lid which in use is elevated to a 45-degree angle to allow viewing the image in the mirror fixed to the inside of the lid. Price, \$600.

The television controls have been reduced to a minimum of 3 dual controls.

The radio receiver has 12 tubes, 12 W. of output, 12-in. dynamic speaker, 3 frequency bands, and 8-button station selection.

*The WRT-701.* This television console uses a 5-in. kinescope and an 8-tube, 3-band, 6-pushbutton radio set. Price, \$295. Output, 5 1/2 W.; 12-in. dynamic speaker.

The WRT-702 televisor contains a 9-in. kinescope and 12-tube radio receiver similar to the above unit. This receiver has the kinescope mounted horizontally. Thus the image screen and all controls are on the face of the cabinet. Television controls and radio chassis, same as WRT-703. Price, \$450.

*PILOT.* An oldtimer in television—as time is counted in this field—is Pilot Radio Corp., which began public demonstrations with scanning-disc equipment in 1927. Culminating laboratory work on electronic equipment is the Pilot model T-90 just announced; shown on page 723. This is a 20-tube, high-definition, high-fidelity television receiver using a superheterodyne circuit.

Among the innovations in this receiver, is a full automatic raster control, specifically designed to prevent the formation of spots and blemishes on the screen, and to prevent damage to the cathode-ray tube while it is warming up. In line with this feature, the receiver also has an automatic background lighting control, enabling the reproduction of the exact degree of brightness, as transmitted at the original scene. The intensity control is then operated only to set the brightness level.

The images, on a 9-in. screen, are black and white, and of sufficient brightness to be viewed in daylight.

Prices on entire line: 9-in.-tube table model, \$250; 9-in. console, \$295; 12-console, \$475.

*STEWART-WARNER.* The Stewart-Warner television set (see page 723) claims a distinctive high-fidelity sound channel that adds realism to the reception. Complete instrument has 25 tubes, with 12-in. C-R tube.

Please Say That You Saw It in RADIO-CRAFT



**Now..**  
**5 VITAL FEATURES**  
**COMBINED IN**  
**AMPERITE VELOCITY**  
**WITH ACOUSTIC COMPENSATOR**



- it's a VELOCITY
- it's a DYNAMIC
- UNI-DIRECTIONAL
- NON-DIRECTIONAL
- HIGH OR LOW PITCH

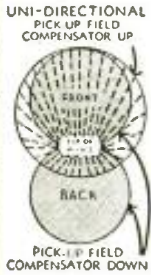

By moving up the Acoustic Compensator, you change the Amperite Velocity Microphone to dynamic operation — without peaks. At the same time you reduce the back pickup, making the microphone practically UNI-DIRECTIONAL.

With the Acoustic Compensator down, the microphone is BI-DIRECTIONAL... 120 degrees front and back without frequency discrimination. Rotating the microphone until it parallels the ceiling makes the microphone NON-DIRECTIONAL.

**THE ACOUSTIC COMPENSATOR** is a regular feature of these models: RBHk (hi-imp); RBMk (200 ohms) LIST \$42.00. RSHk (hi-imp); RBSk (200 ohms) LIST \$32.00

Write for Complete Illustrated Bulletins and Valuable Sales Helps

**AMPERITE Co.** 561 BROADWAY, N. Y. Cable Address: Alkema, New York  
**AMPERITE Velocity MICROPHONES**

GET A REAL ELECTROPLATING KIT ABSOLUTELY FREE! Complete details as to how it is possible to get a real electroplating kit FREE, appears on Page 765 of this issue.

**DESIGNED FOR THE FUTURE**



**30**  
**TUBE**  
**CUSTOM**  
**BUILT**

**SCOTT PHILHARMONIC**  
 "World's Finest Radio"

Radically new (years ahead) engineering equips this amazing instrument with features that will keep it up-to-date far into the future. Six hands cover all wave lengths from 4.7 to 2000 meters including television sound reception! Overall fidelity 30 to 16,000 cycles, about 4 times the tonal range of average production-type radios. Five noise reducing systems. About 7 times more powerful. 5 times more selective. 6 times more sensitive than the average receiver. Tonal realism is so great you seem to feel the presence of the artists. Although custom-built by hand in laboratories with infinite skill and precision, the SCOTT costs no more than many mass production receivers.

**30 DAYS HOME TRIAL**

Enjoy the incomparable performance of the Scott Philharmonic in your home for 30 days—(U.S.A. only)—budget plan available. Guaranteed 5 years. SOLD DIRECT FROM OUR LABORATORIES ONLY. Send coupon today.

**GET SPECIAL OFFER!**

**E. H. Scott, Radio Labs., Inc.**  
 4404 Ravenswood Avenue,  
 Dept. 2499, Chicago, Ill.  
 Send all the facts, order blank, and special offer. No obligation.



Name .....

Address .....

STUDIOS: Chicago, New York, Detroit, Buffalo, Los Angeles



Fig. 8. This illustrates the unpleasant effect secured with a non-linear vertical scan. The distances  $a$  and  $a1$  normally should be equal. The image is badly distorted.

**SERVICING TELEVISION RECEIVER FAULTS**

(Continued from page 715)

oscillator serves admirably. Alternatively most service oscillators will readily furnish these frequencies. (As a matter of interest the writer used the scan voltage of a high-frequency oscilloscope.)

This test pattern is of particular value for determining the linearity or otherwise of the scan when no transmission is available. One point requires observing, otherwise the tests are completely valueless. The time bases *must* be operating at substantially the correct speeds for there is little object in achieving linearity at entirely incorrect operating frequencies.

The simplest way of insuring this is to adjust the time bases accurately to the correct frequency during a transmission. Greater accuracy is insured by making the sync-pulse amplitude very small, then, by applying signals in the manner indicated, the number of bars and the frequency to produce these can be noted, and these settings repeated at any time. Of course, if the frequency of the modulating voltage is fairly accurately known it is a simple matter to calculate the number of bars that should be produced when the time base frequencies are correct, and this is an alternative adoptable scheme.

**LINEARITY**

Now to insure linearity, adjustments are made until the spacing of the bars is even over the whole screen. The photograph, Fig. 6, shows the test pattern for linearity in the vertical (frame) time base and is secured by feeding a low-frequency signal to the modulating electrode. Actually slight non-linearity is indicated, but is not serious. Figure 7 shows the same scheme employed for checking linearity in the horizontal sense (line). Even spacing of the bars should be striven for.

Finally, Fig. 8 shows the unpleasant effect secured with a non-linear frame (vertical) scan. The distances  $a$  and  $a1$  should be equal. It is seen that the image is badly distorted, the servant girl's face dominating the image, while the other character's features are compressed. The rounded corners of the image are due, of course, to the cathode-ray tube bulb curvature. The corners of the raster should not be permitted to wander much over the screen's periphery for apart from the loss of image subject, particularly in captions, this rounded-edge distortion becomes objectionable.

Before we leave this question of non-linearity of sweep voltage it is as well to mention that included in this category are the following faults:

Overload of the scan voltage amplifiers. As the types of tube normally specified for such positions can handle easily the grid

signals involved it is not proposed to deal with the question in any detail.

The question of balance in a push-pull deflector plate feed system has also been remarked. If the balance is not reasonably good an asymmetrical scan will result. This effect is a form of non-linearity, though in the writer's experience other defects thus caused are more deleterious. It has already been pointed out that the balance should be such that each tube contributes approximately one-half the scan. If this requirement is observed then no trouble from this source will be experienced. The condition is satisfied by making the paraphase tap at 1/Mth. of the anode resistance. (M is the magnification of the stage.)

These conditions are usually allowed for, as is also that of freedom from amplitude, phase and frequency distortion, in the amplifier's design. From a designer's viewpoint they are important, however, and should receive due attention.

Incidentally the frequencies involved can be deemed to be of the order of 20 times the fundamental operation frequency of this time base.

A study of all these photographs will reveal one fundamental fact. Any non-linearity of the scan voltage developed by the sawtooth oscillator is revealed as a compression of the right-hand or the bottom image edge.

No attempt to cure image distortion occurring as a compression of the left-hand image edge should be made in the manner outlined above. This defect will be dealt with later. It is due either to non-linearity of the flyback, though this is rare, or to the line retrace occurring with insufficient rapidity. Actually the first effect is often a corollary of the second and in any case is not important unless the interval occupied is greater than a certain percentage of the line time.

In the next article of this series trapezium distortion and also actual image defects will be dealt with.

(To be continued)

**CORRECTION**

On pg. 151 in the September 1938 issue of *Radio-Craft* mention is made of audio trouble encountered in a Sentinel model 73B. We are informed by the Sentinel Radio Corp. that model 73B does not use a type 75 tube as mentioned in the article. The Sentinel company did have a model 72A which may be the receiver referred-to because the latter did use a type 75 tube. The A.F. howl may have been due to moving the grid lead from its original position. Engine doesn't remedy circuit oscillating.

Please Say That You Saw It in RADIO-CRAFT

## HOW TO BUILD A TINY 23/4- POUND 5-TUBE BATTERY- PORTABLE BROADCAST SUPERHET.

(Continued from page 717)

- Two International Resistance Co. resistors, 1 meg., 1/2-W.;
- One International Resistance Co. resistor, 0.25-meg., 1/2-W.;
- One International Resistance Co. resistor, 0.5-meg., 1/2-W.;
- One International Resistance Co. resistor, 500 ohms, 1/2-W.;
- Two Solar Mfg. Co. domino paper condensers, 0.25-meg., 200 V.;
- Two Solar Mfg. Co. domino paper condensers, 0.1-mf., 200 V.;
- One Solar Mfg. Co. mica midget condenser, 100 mmf.;
- One Solar Mfg. Co. mica midget condenser, 250 mmf.;
- One Solar Mfg. Co. mica midget condenser, 500 mmf.;
- One Solar Mfg. Co. mica midget condenser, 0.005-mf.;
- One Solar Mfg. Co. mica midget condenser, 350 mmf.;
- Four Solar Mfg. Co. paper condensers, 0.01-mf., 200 V.;
- One Carter Radio Co. midget variable resistor, 50,000 ohms;
- One Carter Radio Co. short jack, circuit-closing type, P;
- One Carter Radio Co. D.P.S.T. toggle switch;
- One sheet aluminum, 7 x 10 x 1/16 ins.;
- One case with handle;
- Two Winchester Co. midget variable condensers, 420 mmf.;
- Three \*Hivac type SG tubes, 1.5 V.;
- One \*Hivac type Y tube, 1.5 V.;
- One \*Hivac type D tube, 1.5 V.;
- Four \*Hivac 4-prong sockets;
- One \*Hivac 5-prong socket;
- One Aladdin Radio Industries, Inc., I.F. transformer, No. C100-M, 465 kc., T4;
- One Aladdin Radio Industries, Inc., I.F. transformer, No. C101-M, 465 kc., T3;
- One Aladdin Radio Industries, Inc., antenna coil, No. 500, T1;
- One Aladdin Radio Industries, Inc., oscillator coil, No. 2000, T2.

(\*Available from most radio mail order houses.)

## SERVICING QUESTIONS & ANSWERS

(Continued from page 734)

for the R.F. and 1st I.F. screen-grids is obtained from the voltage divider at a point of lower potential than their respective cathodes. Also the voltage applied to the divider comes from the cathodes of these same tubes. Still, when these same tubes are removed from the set, about the same voltage seems to exist on the divider.

When the voltage is applied to the set the divider overheats considerably.

When this set first came in I found a shorted bypass condenser, connected to the plates of the R.F. and I.F. stage, which ruined the tuning indicator. I did not renew the entire condenser bank as the rest seemed OK.

Kindly give me any assistance possible on this set.

(A.) The receiver you describe is the Montgomery Ward model 1238 (62-1838). We believe your difficulty lies with an open-circuited section of the voltage divider. Check your receiver back carefully with the diagram, noting voltage divider values.



—and you've asked your hundreds of questions about the new SUPREME 504 Tube and Set Tester since it was introduced a few short weeks ago. Grouping and analyzing these questions we have attempted to answer them all in the seven paragraphs below.

**WHAT IS THE OVER-ALL ACCURACY OF THE 504?** The 504 has an OVER-ALL GUARANTEED accuracy of 2% on all D C. and 3% on all A.C. functions. Contrast this with instruments in which ONLY THE METER is guaranteed to 2% or ONLY THE RESISTORS to within some percentage. SUPREME guarantees the accuracy of the ENTIRE INSTRUMENT—not just one component part.

**IS THE COPPER-OXIDE RECTIFIER GUARANTEED?** Unconditionally! The copper-oxide rectifier is completely guaranteed for 90 days—exactly the same as every other part. As far as we know, SUPREME is the only company which guarantees instrument rectifiers.

**WILL THE A. C. VOLTAGE READINGS VARY WITH TEMPERATURE?** The 504 incorporates an entirely new "Perma-Grad" TEMPERATURE compensated circuit. Each rectifier is individually matched with a specially wound spool of HYTEMCO wire which nullifies the result of temperature change on the rectifier by reacting in the opposite direction. Thus accuracy is not guaranteed at only one temperature but is guaranteed to be well within 3% over a wide range of 40 degrees to 95 degrees. Even above or below these limits variation is negligible. THIS IS AN EXCLUSIVE FEATURE.

**WILL THIS TESTER CHECK LEAKAGE OF ALL ELECTROLYTICS?** The 504 is also a complete condenser analyzer and will check leakage of all electrolytics, regardless of the CAPACITY or the WORKING VOLTAGE. There are seven D. C. test

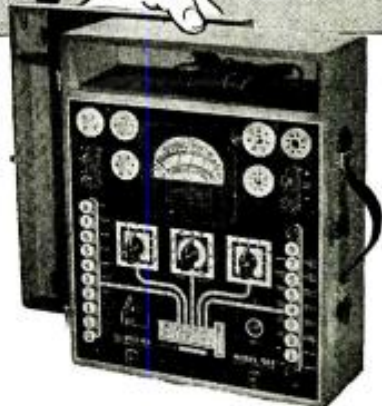

voltages from 25 to 450 volts with complete listings on the roll chart. Tests are made on an English reading scale and discard limits were set with the co-operation of three of the leading condenser manufacturers.

**I AM AFRAID TO BUY A TUBE TESTER BECAUSE MANUFACTURERS ARE SWITCHING AROUND THE ELEMENTS ON THE NEW TUBES.** The 504 has a "PATENTED DOUBLE FLOATING FILAMENT RETURN SELECTOR" and an obsolete-free basic circuit which automatically re-connects every tube socket to the proper arrangement while the instrument is being set-up according to the tube chart. This is done REGARDLESS OF PRESENT OR FUTURE TUBE BASE CONNECTIONS. There are now about 120 different bases—the Model 504 does not care if there are 1000 or more. THIS IS AN EXCLUSIVE FEATURE.

**WILL THE 504 TEST 50-VOLT TUBES?** Yes, the 504 will check 50-volt filament tubes as well as 35, 32, 7, 1.4, and all other types. It will check loctals, single-ended "S" types, gaseous rectifiers, magic eyes, ballast tubes, pilot and flash lights, G, MG, M, GT, octals and non-octals.

**I AM SOLD ON THE INSTRUMENT BUT I DON'T THINK I CAN AFFORD IT.** If you can afford a telephone or if you can afford to buy your cigarettes you can afford the Model 504. This big Model 504 laboratory, combining a 7-way tube tester, a 31 range set tester, and a complete condenser analyzer, is but 17c per day on the world's easiest installment terms.

If you want further details on this newest of new instruments, send coupon below.

# SUPREME

SUPREME INSTRUMENTS CORP.  
GREENWOOD, MISSISSIPPI, U. S. A.

EXPORT DEPT., Associated Enterprises Co., 145 W. 45th Street, New York  
Cable Address: LOPREH N. Y.

**MAIL COUPON TODAY!**

SUPREME INSTRUMENTS CORP., Dept. C-5  
Greenwood, Miss.  
Please RUSH me your newest information on SUPREME 504 and many other completely new SUPREME 1939 Models.

Name \_\_\_\_\_  
Address \_\_\_\_\_  
City \_\_\_\_\_ State \_\_\_\_\_

## Be a RADIO EXPERT - Learn AT HOME

### RADIO SPECIALISTS NEEDED

Modern receivers with their complicated circuit systems have knocked out the old time cut-and-try radio fixer. Trained men with up-to-the-minute knowledge are needed to service these new sets.

### HERE IS YOUR OPPORTUNITY

Your possibilities of making money and getting ahead are limited only by your ability and skill—but you must know more than the other fellow. You must be a radio service specialist, as R.T.A. can train you.



FREE

OF EXTRA COST  
To start your making money without delay we equip you with this Circuit Analyzer and Point to Point Resistance Tester.

### PRACTICAL TRAINING AT HOME

Our home study course is practical "shop and bench" training combined with a thorough set of practical lessons prepared by an experienced Radio service engineer. Four working outfits are also furnished.

### MAKE SPARE TIME MONEY

Our training is complete and practical. We show you how to make money almost from the start. The course can easily be made to pay its own way. Investigate now, write for free book of details.

### WHAT R.T.A. STUDENTS SAY

Norwood, Ohio  
I have connected with a large firm as Radio Service Manager and wish to extend my thanks for your help.  
Joseph Rapien, Jr.

Yorkville, Ohio  
From Aug. 1 to Dec. 7, 1938, I repaired 163 radios and put up 43 serials which is very good for part time work while studying your course.  
Chas. Koerber.

RADIO TRAINING ASS'N OF AMERICA  
Dept RC-69, 4525 RAVENSWOOD AVE., CHICAGO

Please Say That You Saw It in RADIO-CRAFT

**SERVICING SIMPLIFIED  
With A.T.A. INSTRUMENTS!**

**710-SELECT-O-TESTER**

Unbeatable for accuracy, reliability and cost. Makes use of sensitive 1000 ohm per volt D'Arsonval meter. Large easy to read scale. Needle type pointer.

- 0/2.5/10/25/50/100/250/500/1000/2500 volts D.C.
- 0/10/100/1000 D.C. Mills.
- 0/2500/25000/250000 Ohms.

With battery and prods **\$5.85**



**MODEL 720 A.C.-D.C. TESTER**

Similar in design but has the following A.C. ranges added—

- 0/15/150/1500 Volts A.C.
- 0/15/150/1500 Output
- -10 to plus 19/38/53 db.

With battery and prods **\$7.85**



**740-GIANT ALL-TEST-METER**

Employs huge 9" 1000 ohm per volt D'Arsonval Meter—

- 0/15/150/750 Volts D.C.
- 0/15/150/750 Volts A.C.
- 0/1/15/150/750 D.C. Ma.
- 0/15/150/750 A.C. Ma.
- .001/1 and .05/200 mfd.
- 0/500 and 500/5 megohms
- 0/15/150/750 output ranges
- 1/700 henries ● .006/600 Watts.

With prods Complete **\$18.95** Cover extra \$1.00

**APPROVED TECHNICAL APPARATUS CO.**  
57½ DEY ST., N. Y. C., N. Y.  
SEND FOR NEW A.T.A. CATALOG

**DATAPRINTS**



**TESLA-LOUDIN HI-FREQ. COILS**

- 20c Ea. in order for 10 (Data and Drawings only.)
  - 36" Sp'k Tesla-Oudin Coil 40c (1 K.W. Exc. Trf. Data, included FREE!)
  - 8" Sp'k Tesla-Oudin Coil 40c (¼ K.W. Exc. Trf. Data, included FREE!)
  - 3" Sp'k Oudin; 110 Vt. "Kick Coil" type.....40c
  - 3" Sp'k Tesla Works on Ford Sp'k Coil .....40c
  - 1" Sp'k Violetta Hi-Freq. Coll.....40c
- FREE with order \$1.00 or more—20 Tricks with Hi-Freq. Coils (40c separate)

**20 ELECTRIC PARTY AND LODGE TRICKS!**  
Loads of Fun!

How to Shock 'em!.....40c  
See special price below and save.

Television Hook-Up—Sight & Sound.....40c  
—Get List!

**SOLENOID & MAGNET DATA**

**YOU need these DATAPRINTS!**

- 20 Telephone Hook-ups Welding Transformer, 2 K.W.
- 100 Mechanical Movements Rewinding Armatures
- 20 Motor Hook-ups Einthoven String
- Resistance Measuring Galvanometer
- Bridge 20 Simple Bell Circuits

Special Prices:  
4 prints \$1.00; 10 for \$2.00;  
40c each, single orders.

**The DATAPRINT Co.**  
Lock Box 322C, Ramsey, N. J.

**THE RADIO MONTH IN REVIEW**

(Continued from page 711)

speakers that were set up on a balcony.

Another outstanding achievement brought to light at this meeting was the G.E. high-fidelity loudspeaker now standard in the new "F.M." receivers of the same make. A smoothly-graded range in the thickness of the loudspeaker diaphragm serves to maintain uniform compliance right out to the carpinchoe edge of the cone. The result is a unit readily capable of handling over 9 W. with a frequency range  $\pm 1$  db., of 30 to 18,000 cycles!

The General Electric technicians in reporting on experiments conducted in the Schenectady area pointed out that the transmission areas of the Schenectady and Albany stations overlapped only over a band about 2 miles wide; at certain points in this area one or the other station, with both operating on identical frequencies in the 41-megacycle region, could be tuned in or out merely by pushing the antenna on the test car a few inches!

At present, A.V.C. in the receiver is required to prevent cross-modulation, but the Major pointed out that A.V.C. may not be necessary. It was also stated that a total of 3 I.F. stages is required, each with a gain of 15 to properly drive the limiter—the key unit in a set capable of receiving frequency-modulated programs—which requires a swing of about 10 V.

Unlike amplitude-modulation ultra-S.W. receivers, which require a dipole or other, and comparatively complicated, type of antenna, a short length of wire may be extended from the receiver to act as an aerial for frequency-modulated signals; it was even possible, he demonstrated, to bunch this wire and place it immediately in back of the set, and still receive the signals—with negligible change in volume and only a slight increase in background noise.

Answering a question uppermost in the minds of many of his listeners, Major Armstrong stated that television may well continue as an amplitude-modulation service on the frequencies at present assigned to this field. Though it may be desirable at some future date, when improvements in equipment make it practicable, to transmit frequency-modulated television programs on some micro-frequency range (such as 1,000 megacycles).

**MORE SOUND**

*The Spanish Civil War*, now history, included "broadcasts" over loudspeakers last month, by Insurgents on the Catalonia front, of appeals to Loyalists to surrender. While Rebels on the Madrid-Valencia front used loudspeakers to tell Loyalist soldiers of the fall of Barcelona.

We've often wondered how to be in two different places at the same time. Ellsworth C. Dent, RCA Victor Educational Director, solved the problem last month by using a sound recording, made by means of new RCA Victor recording and playback apparatus, to address a meeting of the Kansas State Music Teachers' Assoc. held at Winfield, Kans., while he personally attended another important conference in his office at Camden, N. J.

The recording reached Kansas via Air Mail and was played-back on the same type of machine on which it had been recorded. This demonstration helped clinch arguments pointing to the need for recording-playback machines in schools. *Radio-Craft* urges Servicemen and Servicemen-dealers to look into their local school-sales angle.

**BROADCASTING**

If you live in Leningrad, it costs you no more than your monthly telephone bill to receive radio programs, *The Christian Science Monitor* (Boston, Mass.) reported last month. This "centralized radio system" of the Soviets is said to work like duck soup—at a cost for receiving equipment that is practically nil. If a phone call arrives during a program the broadcast is automatically side-tracked during the duration of the call.

The early morning broadcast from Vatican City during the coronation of Pope Pius XII, last month, on short waves was received by WOR and rebroadcast. It was also recorded; later the recording was condensed in a re-recording, and re-broadcast to listeners who constituted a larger audience at a later hour that morning.

If you are interested in learning radio in alphabetical order, the A, B, C portion is now available, from the National Association of Broadcasters, Washington, D.C., with other "letters" to follow. Exact title of the 20-page booklet is, "The A B C of Radio—So That the Average Listener May Understand How It Works in America."

**FACSIMILE**

MEMBERS of the Radio Servicemen of America last month witnessed a demonstration and explanation of modern facsimile and its application, under the able M.C.'ship of J. R. Poppele, chief engineer of WOR.

At the meeting, W. G. H. Finch's alert Mr. Ehlert showed *Radio-Craft* comparative pictures received by Mr. Poppele from station WOR, and DX transmissions from WLW in Cincinnati and WGN in Cleveland. The local (WOR) "copy" was as clean-cut as newsprint. These 3 stations—which constitute the new Mutual Facsimile Network—are said to be serving at the present time approximately 1,000 facsimile receivers.

Mr. Poppele, in discussing the servicing angle of facsimile, remarked that the radio Serviceman is going to require more than his present fund of radio and electrical knowledge; said he: "A complete machine shop would almost be required to properly service present-day facsimile receivers."

It was stated that the synchronizing signal is about 3 db. greater than the picture signal. The flying spot at the transmitter is only about 0.01-in. in diameter; and the current required to darken the paper at the receiver is only about 0.01-ampere at about 150 volts. The picture is reproduced by amplitude modulations (corresponding to the light and dark areas) of a 2,000-cycle tone.

Technicians are now toying with the development of a tuned reed arrangement which will make it possible to turn home receivers on and off at will from the transmitter!

WOR estimates that in 5 years about 500,000 facsimile receivers will be operating in the metropolitan area (which will then have a primary service area from Philadelphia, Pa., to Hartford, Ct.). This area will accommodate 150 facsimile transmitters; these figures involve an estimated \$40,000,000 investment for equipment (basing this on 17 years of sound broadcasting). And about \$7,500,000 will be spent

Please Say That You Saw It in RADIO-CRAFT

by the consumer for receiving equipment; and service charges, including the cost of tubes and paper, should not exceed \$15 per year. The bill for electric current for early-morning signals only, it is estimated will be about \$7,300,000—with the facsimile transmitter keying the receiving equipment on and off to insure least operating cost.

School facsimile was demonstrated over the ultra-H.F. transmitter of station WBOE to Cleveland school authorities last month. Lesson instructions, announcements, maps, etc., appeared simultaneously on RCA facsimile receivers in 4 city schools. Radio-Craft hopes Cleveland radio men are getting-in on this business; and that radio men in other cities throughout the U. S. recognize opportunity when it thus batters down the door.

**UNDER 200 METERS**

**A** QUINCY, MASS., radio instructor was aided in averting a tragedy last month by a short-wave radio set, which he installed 5 years ago under similar circumstances, in bringing rescue to himself and 13 others in a snow-bound group near his week-end cottage.

The U.S. Army Air Corps has supplied facilities to the Civil Aeronautics Authority for testing at Wright Field, Ohio, a blind-landing device that operates on a microwave only 16 ins. long. The position of the airplane on the glide path is indicated by a tiny dot of light on the end of a cathode-ray tube.

R. C. Newhouse, Bell Telephone Labs. technician, last month snagged the Lawrence Sperry Award for his outstanding contribution to airplane radio—the terrain clearance indicator. (See "New Radio Altimeter Increases Air Safety," Jan. 1939 Radio-Craft.)

Two police officers of Milwaukee had the unique experience of hearing the short-wave set in their squad car blare out instructions to go to a designated point where, a passing motorist had telephoned to headquarters, there was an automobile in a ditch. At the moment, the officers were crawling out of said car!

Somewhat reminiscent of the Zworykin multiplier tube is the new smaller, cheaper, lighter and more effective, \$7,000 atom-smasher announced last month by Dr. Lloyd P. Smith, physics professor at Cornell University.

A short-wave radio generator alternately charges with negative electricity the far end of each of 7 metal tubes contained in one vacuum tube 6 ins. in diameter and 8 ft. long. Polarized at 70,000 V. the resulting positive atoms of a gas introduced at one end of the tube shoot forward at increasing speed through the 7 tubes.

We quote without comment an A.P. report from Prague last month: "General von Heppened, German army commander in Prague, today ordered that all amateur radio sending sets be surrendered to the police. There were several hundred transmitters in Bohemia and Moravia."

**TECKNICK-NACKS**

**I**T'S a stunt-and-a-half which Norsk Telefunken Radioaktieselskap was reported last month to have worked-up for Norwegian whalers. After the whale has been killed by harpooners in small-boats, a lance equipped with a water-tight, battery-powered radio transmitter is attached to the floating carcass. Its 600- to 800-meter signals enable the mother ship, by means of a direction finder, to locate the whale.

On pg. 711 is illustrated Radio beacon 10 which was installed in North Channel, Boston Harbor (Mass.), last month. This experimental radiobeacon aid to navigation transmits 5 dashes every 15 seconds on 310 kc. over a range of about 4 miles. Antenna is 15 ft. high.

Patent No. 2,143,406 granted to Stanley B. Chamberlain of London, last month, relates to a paper which holds electricity. Designed for banknotes and documents to thwart forgery.

Atoms are held together by electrical forces many hundreds of times more powerful than the force of gravity which holds the stars and planets in their orbits, but apparently the force of 200,000,000 V. necessary to rend atoms asunder was self-obtained last month by the explosion of atoms.

The accomplishment was reported at Carnegie Inst. of Washington and George Washington Univ., last month, to have been made by Dr. G. Hahn, of Berlin, by bombarding the synthetic element known as ekauranium with neutrons and thus producing the fluorescent material barium. The only way that this could occur, according to physicists, would be for the ekauranium atom to split apart (to form barium and the rare element masyrium).

By means of an Abraham low-inertia oscillograph and a du Mont cathode-ray oscilloscope, it has been possible to analyze the waveform of natural static and thereby determine whether a storm is within 300 miles, according to La Nature (Paris, France) in reporting a communication to the French Academy of Sciences, Paris.

Breaking an invisible black-light (infrared ray) beam focused on an electric eye in a Los Angeles photographic shop made it too, too annoying for 2 members of the light-finger gentry who attempted to get away with \$500 worth of loot. The photoelectric set-up had registered in the offices of a merchants' patrol.

If you plan to set up a photoelectric burglar alarm be sure to exercise plenty common sense. A false alarm in a Kansas City warehouse last month was tracked to a cat's tail which had interrupted an alarm beam focused on an electric eye.

**BREVITEMS**

**W**E salute that Serviceman-genius who incited the co-eds of Jackson College (Medford, Mass.), the women's department of Tufts, last month to issue the ultimatum: "Radios within a month or we resign."

(Continued on following page)

**DEALERS! SERVICEMEN! AMATEURS! SOUNDMEN! BUILDERS!**

Send For THE BOOK WITH RADIO'S GREATEST VALUES! IT'S FREE!



**Latest P.A. at New Low Prices!**  
Now, the greatest P.A. values ever offered! Systems for every purpose—8 to 65 watts—standard and de luxe models—permanent, portable, and mobile. Newest features, Monitor Speaker, Remote Control, etc. Illustrated, America's finest Mobile System. See, also, new P.A. accessories, transcription players, latest recording equipment, discs, etc., in ALLIED's new Spring Catalog! Get Time Payment details and story of the strongest P.A. Guarantee ever made!

and **NEW SETS!**  
New KNIGHT Radios, with Push-Buttons, built-in "Air-Magnet" aerials—at new low prices! 60 models—Portable, AC, AC-DC, 1 1/2, 6, and 32 volt, etc., as low as \$3.95!—and radio's biggest line of record players, phonographs, phono-radios!



**NEW KITS!**  
Messner 1, 2, 3 tube, "Fee-Wees", Television, Phono and Mike, many others! Write for Free Parts Lists! Builder's Handbook—10c. For beginners—tells how to read diagrams, build sets. Only 10c.



**NEW "SEND-CEIVER"**  
A sensational new Guthman-Silver "Ham" kit. Consists of 6-band 2-tube receiver with 6 band crystal-controlled transmitter all in one unit. Ideal for portable work, beginners, vacation work, etc. Amazingly low-priced!



**TESTERS—PARTS!**  
All leading lines—new equipment with provision for new Lectal Tubes, etc.—Tube Checkers, Set Testers, Analyzers, Oscillographs, Meters—and over 14,000 parts at lowest prices! Everything in radio in one big book!



Fastest Service, Highest Quality, Lowest Prices always! Write for ALLIED's new Spring Catalog!

**Free!**  
**SEND COUPON**



**ALLIED Radio Corporation,**  
Dept. 2-F-9  
833 W. Jackson Blvd.,  
Chicago, Ill.

Send me your new FREE Spring Catalog.  
 Enclosed find 10c (plus 3c postage) for Builder's Handbook.  
 Send full details on "Send-Ceiver".

Name .....  
Address .....  
City ..... State .....

Please Say That You Saw It in RADIO-CRAFT

Precision Engineered  
Quality Built  
Economically Priced

## CINAUDAGRAPH SPEAKERS

for all service and public address applications.

Precision engineered—quality built—and economically priced Cinaudagraph Speakers have won wide favor in every phase of the radio industry. Sound engineers at the New York World's Fair picked Cinaudagraph Electro-Dynamics for the gruelling job of sound reproduction under all weather conditions. Manufacturers of radio receivers and public address equipment have found Cinaudagraph P.M. and Electro-Dynamic Speakers the answer to dependable service.

You too, can take advantage of the added "value" of Cinaudagraph Speakers. No matter what your replacement or "sound" requirement, there's a Cinaudagraph Speaker available. PRECISION ENGINEERED. QUALITY BUILT. ECONOMICALLY PRICED. Available at all leading distributors.



Literature on request.

CINAUDAGRAPH CORPORATION  
STAMFORD CONNECTICUT

## BRUSH

### BJ HEADPHONES

Communications type—lightweight, durable aluminum case—phones encased in molded rubber jackets—good earseal.



Write for your Brush catalog today

THE BRUSH DEVELOPMENT CO.

3311 Perkins Ave.

Cleveland, Ohio

SOLAR gives you MORE for your money

# MINICAP

Catalog upon request

SOLAR MFG. CORP., 599 Broadway, New York

## THE RADIO MONTH IN REVIEW

(Continued from preceding page)

They said, "If Tufts can have radios in their rooms, why can't we?"

"Oomph," brought under the radio man's microscope, now may be defined as "D.C. variations." Dr. Loving, physicist at the University of Richmond (Va.), set up a "kissometer" for checking the osculatory factor or oomph of human guinea pigs; girl holds one electrode and boy holds the other—a kiss, and meter-needle jumps. *Radio-Craft* readers might like to try this game of "Radio Postoffice" by using the simple "lie detector" (based on indications of D.C. variations) described in the Dec. 1935 issue.

The "scrap of paper" which England has made of the international agreement in 1912 to drop the term "wireless" in favor of "radio", left-handedly flew into the face of the British Air Ministry, last month. The Ministry, in a report on the forced descent of the New York-Bermuda flying boat *Cavalier*, in which accident 3 persons lost their lives, criticized the American press for mistaking the use of the term "to earth" to mean bringing the ship to earth. When Capt. Anderson radioed the message, "Running into bad weather, may have to ground the antenna because of static conditions.

Static electricity (presumably due to friction) was blamed for causing the death last month of a 21-year-old patient at Roosevelt Hospital (N.Y.). Cyclopropane gas, which was being used as an anesthetic, exploded.

The "Rome-Berlin radio axis," Herr Goebels called it, when he recently spoke before a concert inaugurating closer radio cooperation with Italy.

### MORE TELEVISION

THE RKO-Radio Pictures production, "Gunga Din", starring Cary Grant, Victor McLaglen, Douglas Fairbanks, Jr., has been condensed into a 1,000-ft., 10-minute sound-film expressly for television broadcasting by N.B.C. This production makes history as a pioneer telefilm.

We do not know whether he originated it, but at least it was in Orrin E. Dunlap, Jr.'s, column of the *New York Times*, last month, that we first noticed use of the word *telegenic*. It's a swell term for signifying that a person televises well.

NANA (British news agency) reported to the *New York Times* last month that British television was said to be operating on a schedule of about 18 hours per week, serving 10,000 sets with a potential audience of about 50,000 lookers-in.

A Reynolds (British news agency) correspondent reports that during the last 2 years the B.B.C. has televised 86 plays from the Alexandra Palace studio-theatre.

A U.S. Dept. of Commerce report places B.B.C.'s "capital expenditures" for television service at about \$625,000; "revenue expenditure," \$3,300,000.

The G.P.O. has laid a coaxial cable which passes points of interest in London it may

be desired to televise. Cable connects with Broadcasting House and Alexandra Palace.

From the Office of the American Commercial Attache, Rome, to the U.S. Dept. of Commerce: Italy plans the "early initiation" of television; the studio of E.I.A.R. requires only the finishing touches. It is planned to install 50 television transmitting stations during the next 12 to 18 months. Operation will be on 5 meters.

"What is Television?" According to *Variety*, Gerald Cock, B.B.C.'s television chief, had prepared for him an official answer to this question. Framed in his office at Alexandra Palace, the answer slows up most questing visitors; it runs as follows:

"Excited by impulses born on a carrier wave which vibrates 45,000,000 times a second, a spot of light 1/32-inch in diameter, traveling at the rate of 6,000 miles an hour, and varying in its illumination up to 4,000,000 times a second, traces 25 times a second in alternate lines a page of 405 lines on the sensitized end of a cathode-ray tube. Vision and sound signals are synchronized to within a quarter-millionth part of a second. . . ."

A new cubic television antenna announced last month solved problems in connection with General Electric's television station, W2XB, near Albany (N. Y.). The antenna consists of 8 hollow copper bars, each 4 ins. in diameter and about 7 ft. or 1/2-wave in length, arranged to form a perfect cube. It is designed to radiate a horizontal polarized wave, carrying both video and audio signals on 4 1/2 meters, 40 miles or more.

The television installation arranged by American Television Corp. at Israel Zion Hospital (Brooklyn, N. Y.) surgical amphitheatre, last month, employed water filters to remove excess heat. Sight and sound monitor facilities in one corner of the operating room were supervised by a technician. The surgeon gave a running commentary on "highlights" of the operation, and occasionally checked on a monitor C.-R. receiving-tube to see whether portions of the surgical technique were being properly picked up by the overhead C.-R. sending-tube.

### RADIO STAMP

For the first time in the history of the art, a radio set figures prominently on a national stamp. The director of the French Post Office issued the stamp (shown below) which is for 90c plus a surtax of 25c which is paid over to the association of "Radio for the Blind." The money will be used to provide especially-designed radio receivers for the sightless. The stamp depicts a blind person listening to a radio set—so get busy you philatelists and see if you can dig up one of these stamps for your collection.

Might be a swell idea if Uncle Sam adopted a similar means to aid those similarly afflicted in our country.—Editor



(Photo—Radio Press Service)

Please Say That You Saw It in RADIO-CRAFT



## BUILD THIS SWITCHLESS 2-WAY INTERPHONE!

(Continued from page 727)

and it is therefore recommended that care be exercised in the selection of such a unit.

The amplifier made by the writer is housed in a chassis measuring 11 x 6 x 8 ins. Its weight is approximately 9 lbs. The on-off switch shown in the circuit diagram may be operated through a relay, from either one or both of the remote stations, if this feature is desired, although for all ordinary applications, the amplifier is left in the "on" position during the day.

The author will be glad to answer any questions relative to this communicator, if inquiries are addressed c/o *Radio-Craft*, and are accompanied with a postage pre-paid envelope.

(Although the "on-off" power switch is located directly on the amplifier chassis, the constructor, if he so chooses, can extend the power leads to include the switch on one or both of the stations. Of course when the power switch is turned "on," about ½-minute must elapse before the amplifier tubes are ready for operation. This condition may or may not be objectionable, depending upon the individual use to which it is placed. However, if more rapid operation is essential, a "low-heat" switch may be incorporated in order to keep the tube filaments at only ½-heat during the time that the communicator is not in use.

(Another alternative, and this to provide more rapid operation, in a more economical way, is to have an extra filament winding on the transformer supplying approximately 10 V. to the filaments of the tubes which normally require only 6.3 V. As soon as the plates of the tubes begin to draw current, however, a relay in the plate circuit is activated throwing the filament supply back to the 6.3 V. winding. With this latter system it is not necessary to keep the amplifier on at all when the communicator is not in use and yet almost immediate operation can be obtained by throwing the power switch to the "on" position.—*Editor*)

### LIST OF PARTS

- One power transformer (primary, 115 V., A.C.; filament, 6.3 V., 1 A., C.-T.; secondary, 250-0-250 V.);
- One choke, 150 ohms, 30 hys., Ch.1;
- One choke, 300 ohms, 20 hys., Ch.2;
- Two 500-ohm to speaker line transformers, L.T.1;
- One input transformer (primary, 333 ohms; secondary, 50,000 ohms), I.T.1;
- One hybrid output transformer (see specifications), O.T.1;
- One Erie Resistor Corp. resistor, 6,000 ohms, ½-W.;
- One Erie Resistor Corp. resistor, 2 megs., ½-W.;
- One Erie Resistor Corp. resistor, 50,000 ohms, ½-W.;
- One Erie Resistor Corp. resistor, 800 ohms, 1 W.;
- One Erie Resistor Corp. resistor, ½-meg., ½-W.;
- One P. R. Mallory Co. dual condenser, 20 mf., 25 V.;
- One P. R. Mallory Co. triple condenser, 10 mf., 450 V.;
- One P. R. Mallory Co. condenser, 8 mf., 300 V.;
- Two Centralab audio grid taper controls, ½-meg.;
- One Micamold Radio Corp. condenser, 0.01-mf., 600 V.;
- One Micamold Radio Corp. condenser, 0.006-mf., 600 V.;
- One Hygrade Sylvania or RCA Radiotron 6W7G tube;

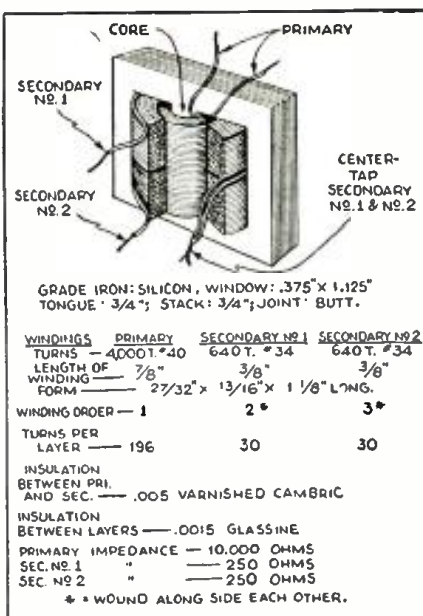

Complete specifications for winding the hybrid coil which makes possible simultaneous 2-way conversation over this interphone system.

- One Hygrade Sylvania or RCA Radiotron 38 tube;
- One Hygrade Sylvania or RCA Radiotron 6ZY5G tube;
- One American Phenolic Corp. 6W7G socket;
- One American Phenolic Corp. 38 socket;
- One American Phenolic Corp. 6ZY5G socket;
- One 100-ohm line balancer;
- One Littelfuse Labs. 1-A. fuse (with mounting);
- One Drake Manufacturing Co. pilot light assembly;
- One chassis;
- One knob;
- One on-off switch;
- One volume plate;
- One tone plate;
- Two good standard P.M. speakers, 6 or 12 ins.

## SERVICING COIN-OPERATED ELECTRIC PHONOGRAPHS

(Continued from page 725)

### SERVICING A MILLS CALL

On another occasion a complaint of low volume was received on a 12-record Mills machine. All voltages were low, particularly the filament voltage on the type 30 tubes, which is taken from the D.C. voltage divider network. The trouble was obviously low line voltage which could not conveniently be corrected. Reasoning that any increase in the D.C. output voltage from the power supply would result in a corresponding increase in filament voltage on the 30's, the rectifier tube was changed from a 5Z3 (original equipment) to an 83, thus restoring the volume of the instrument to normal!

Lack of space does not permit *operating notes* to be included in this issue; however, they will be included in forthcoming articles.

**SERVICEMEN:** You are invited to write to this new department in *Radio-Craft*. If you have problems, please state them briefly and clearly; if you have operating notes or other comments on the servicing of coin-operated Electric Phonographs, just address them to this department.

Please Say That You Saw It in RADIO-CRAFT

## An RCA DOUBLE FEATURE that's good news for you!

FEATURE No. 1

### AMAZINGLY LOW-PRICED AC TEST OSCILLATOR



\$29.95 NET  
Stock No. 153

Here's an instrument that will align even the toughest receivers! This RCA test oscillator features a giant 6" dial—actually more than 50" in length—which makes settings easy to read. The high frequency range alone covers 10"! Frequency range 100-30,000 kc. on fundamentals. Also features stability of circuit design. Uses RCA Metal Tubes. Among its many other features is complete fuse protection. And look at its low price!

FEATURE No. 2

### NEW RCA MULTI-RANGE WAVE TRAP

\$1.85 LIST PRICE  
Stock No. 33033



Here's your answer to the problem of poor reception due to unwanted interference! It's the RCA Multi-Range Wave Trap—frequency range 450-2100 kc. This new unit is tuned by a magnetite core which provides a simple linear and permanent adjustment. It is adequately shielded for protection against interference and reaction with receiver circuits. Attenuation 40 to 1. It is small—easy to install—at a price hard to beat!

Over 325 million RCA radio tubes have been purchased by radio users...in tubes, as in parts and test equipment, it pays to go RCA All the Way.



Test Equipment

RCA Manufacturing Co., Inc., Camden, N. J.  
A Service of Radio Corporation of America

## CONSOLIDATED Volume and Tone CONTROLS



**For Top Performance  
at Low Cost**

FIVE types of controls cover 90% of your replacement calls. Resistances range from 5,000 to 2,000,000 ohms. These units are built to the highest standard of quality based upon years of experience gained in engineering special units for special circuits. They are fully guaranteed.

The five types cover units without switches, with or without intermediate tap—with SP-ST switch, with or without intermediate tap—and with DP-ST switch without intermediate tap. Choose the units for which you have the greatest call and maintain a stock of these individually packaged controls. The investment is surprisingly small.

See them at your jobber's today!

**CONSOLIDATED**  
WIRE AND  
ASSOCIATED  
**CORPORATIONS**

524 S. Peoria St.

Chicago, Ill.

**Always Kept  
UP-TO-DATE**

*Readrite*  
RANGER

only  
**\$21.60\***

\* Complete in Quartered-Oak Case

NEW MODEL  
432

CHECKS ALL  
TYPES RADIO  
RECEIVING TUBES  
• COMPLETE  
SHOWING •

1939-40  
Meters and Testers  
Booth 920  
JUNE NATIONAL  
RADIO PARTS  
TRADE SHOW

- Tests New 1.5-, 35- and 50-volt Series, Local Base Types, 024 and Other Gaseous Rectifiers.
- Separate Plate Tests on Diodes and Rectifiers.
- Neon Short and Leakage Tests.
- Ballast Tube Continuity Test.
- Uses Attractive Triplet, Direct Reading Instrument, 3" Size. (GOOD-BAD) Scale.
- Line Voltage Adjustment.
- New Improved Low Loss Switch.

Write for Catalog—Section 616 College Dr.

**READRITE METER WORKS, Bluffton, Ohio**

**FREE!**

**HAMMARLUND  
28th YEAR  
RADIO CATALOG**

The most complete catalog ever published with illustrations, drawings, curves and a complete description of receivers and foundation units. Write Dept. RC-6-39.

**HAMMARLUND MFG. CO., INC.**  
424-438 West 33rd Street, New York

## RADIO—AT THE WORLD'S FAIRS

(Continued from page 721)

tion outdoors in 4 directions or over a 360-degree area.

Not radio, but of exceptional interest to the technically-minded, is the breath-taking 15-minute trip, with sound, in a simulated rocket ship to the cosmic wonders beyond the earth. The imaginary journey begins at sunrise when the ship shoots from the earth into space. Thereafter visitors are treated to a succession of realistic views, including circular craters, valleys and plains of the Moon, Venus, Mars, the dark nebulae of the constellation Orion and returning to the Earth, by way of the many-mooned and many-ringed Saturn. Man-made meteors, comets and lightning will enhance the return trip. The display is sponsored by the American Museum of Natural History and the Longines-Wittnauer Watch Company.

Some 300 "private guides" will act as almost human escorts to visitors touring the "Highways and Horizons" exhibit of the General Motors Corp. These private guides comprise a gigantic Western Electric sound reproducing system, the main unit of which weighs approximately 20 tons. This unit has a huge revolving drum which carries shimmering ribbon bands of sound-film in front of tiny light needles, whose variation is no greater than 1/1,000-inch.

This new "Polyrheter" delivers just 148 different descriptive talks at the same time. These talks issue from 300 speakers, one each mounted on a double chair, which in turn is mounted on an escalator. The speeches are synchronized to fit whatever part of the scenery each set of 2 chairs in the carry-go-round is passing.

Westinghouse is exhibiting a huge triode radio tube 27 ins. high and 7 ins. in diameter, the purpose of which is to show plainly what goes on inside the 3-electrode vacuum tube; and the effect of the magnetic field on a stream of electrons flowing through a vacuum. It is similar to a standard radio tube except that it has 2 filaments and 2 currents on the opposite sides of the plate so that the action is visible from both directions. The surface of the plate is coated with fluorescent material to give off a green color when the electrons impinge upon it.

The circuit used is similar to that in audio amplifiers. A 60-cycle frequency is applied to the grid, and the tube output is connected to a loudspeaker. The loudness of the audio signal corresponds to the area of the green glow on the tube's plate.

Go to the glassed-in enclosure between the Hall of Power and the Hall of Electrical Living, and the Westinghouse building of the New York World's Fair if you wish to be televised. About 125 persons at a time can see the wonders of television in actual operation as friends selected at random from the crowd perform in front of the cameras.

"Electro" the Westinghouse "Moto-Man"—who carries 260 lbs., stands 6 ft., 10 ins. high, walks, talks, sings, smokes a cigar, distinguishes colors, smells friends, counts on his fingers and does other near-human acts at the spoken command of his director—will greet guests to one of the great halls of the Westinghouse building.

In the Playground of Science (Westinghouse) visitors themselves can become experimenters and operate more than a score of laboratory devices, seeing the shape of their voices, sending music over a beam of

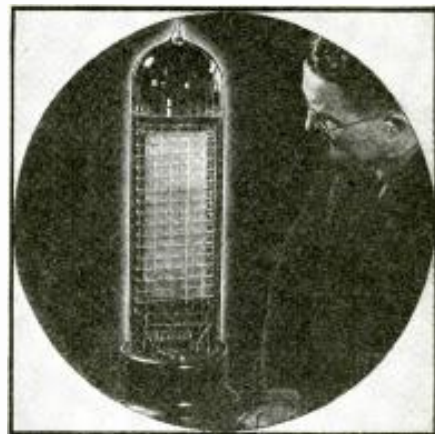

Westinghouse's huge 3 1/2-ft. triode at the New York World's Fair. The plate fluoresces as the electrons bombard it.

light, playing flashlight symphonies on the electrical marimba and turning light and heat directly into electricity.

In the courtyard of a 2-story horseshoe-shaped Westinghouse building is the Singing Tower of Light. Each evening this fantastic "talking rainbow" performs a 15-minute ballet of light and water. A cloud of smoke rises from the pool and metal rings emit smoke until the whole structure is reflected in a cloud. Then from the pool, tower and rings, lamps flood the scene with colored light which changes hues with the cadence of the music. Spouts of water 75 ft. high climb from the pool while lesser jets begin the undulations of the water ballet.

Also at the Westinghouse exhibit, the Phantocycle demonstrates how a light beam balances a riderless bicycle! The Precipitron at the press of a button magically clears dust from furniture. Demonstrating the principles of food sorting, a photocell selects colored ping-pong balls. Westinghouse television is a guest-participation item; and 125 persons can watch. Microvivariums show how "black light" (infra-red rays) kills insects. The Westinghouse Time Capsule, incidentally, is buried under the Singing Tower.

The RCA exhibit building takes the shape of a huge radio tube—symbolic of the entire radio industry—attached to a base and lying on its side; the base forming the front section and the tube forming the rear section. A 40-ft.-high metal-tube replica in a niche at the front is cut away to permit inspection of its animated mechanism. It is on a plot of ground 200 ft. wide and 252 ft. deep, on the Avenue of Patriots, near the Fair's Theme trylon and perisphere.

Ten hours of television programs, picked up daily on 13 television receivers in the RCA exhibit, originate from N.B.C.'s studios in Radio City and are broadcast via the Empire State Building telly transmitter to the Fair. Some programs come from an RCA telemobile unit which cruises around the Fair grounds and the city picking up spectacular pageants, news and sports events. "Vox Pop" television programs, wherein the visitors themselves are interviewed and televised are also presented. A projection-type television receiver sets up an image on a 6 x 10 foot screen!

In addition to television, the RCA exhibit presents special interesting displays of radio, facsimile, broadcasting, international

Please Say That You Saw It in RADIO-CRAFT

radio communications, marine radio communications, sound broadcasting, safety devices and related products of the radio industry.

The Bell System exhibit building, located on a lot 3½ acres in size, borders on the Theme Plaza where are located the trylon and perisphere as the central point of the Fair. Interesting exhibits of the Bell System include the—

"Voice Mirror"—a device which records your own voice as you talk over the telephone and then returns it to you over the receiver;

Your Own Audition—in which 5 visitors—perhaps you among them—converse in a group and then rejoin the audience to hear their conversation apparently repeated by mannikins. (This is a "stereophonic sound" demonstration of such high fidelity it is said to be impossible to distinguish between the original and reproduced sound. Introduced here as the first public demonstration.)

Long-Distance Demonstration—free calls are made by visitors chosen at random. These calls are seen and heard speeding to their destinations in various parts of the country. Their "DX" records are shown by flashing lights on an enormous map. Other lights show how long it takes to make the call. If you are at either of the World's Fairs do not forget to flash a message to *Radio-Craft*.

"Pedro the Voder"—this is an electrical device which creates speech—the first machine in the world to do this. Looking like a small, old, vast organ with a keyboard and a pedal, Pedro converses at the direction of a young human operator.

Other exhibits of the Bell System give visitors an opportunity to test their hearing and their sensitivity to music "pitch." These exhibits are concerned with telephone science and the communication of telephone service.

The chief radio networks cover the New York World's Fair as no Fair has ever been covered before. N.B.C. has a crew of announcers and engineers on the ground almost continuously, and broadcasts news events such as President Roosevelt's Opening Day address, the appearances of royalty and celebrities from this and other lands, when they arrive, and the visit of King George and Queen Elizabeth of England.

C.B.S. microphones are equally prominent, broadcasts being staged from time to time describing unique attractions in the main exhibit and amusement area.

M.B.S. (Mutual) is on hand with its new Periphone mike—a microphone styled to resemble the perisphere and trylon—and a coast-to-coast program titled, "Welcome, Neighbor" which stages interviews with Fair officials and visitors.

Station WLW owned by the Crosley



Westinghouse engineers check the infra-red ray talking beam over which spectators at the New York World's Fair will talk and "see" their voices on a C.-R. oscilloscope.

Radio Corp. of Cincinnati, Ohio, operates from its building to the Communications Zone at the New York World's Fair.

Station WNYC, the Voice of New York, offers a daily calendar of events and "Pleased to Meet You" series of interviews of distinguished visitors.

Messages from the Fair will circle the globe via short waves. Among the stations on the high frequencies are G.E.'s W2XAD and W2XAF, Schenectady, N. Y.; N.B.C.'s W3XAL and W3XL, Bound Brook, N. J.; Columbia's W2XE, Wayne, N. J.; Westinghouse's W8XK, Pittsburgh, Pa.; and Crosley's W8XAL, Mason, Ohio.

General Electric is giving guests at the New York World's Fair not only an opportunity to see television in action but to take part in its programs.

A talent director shepherds them before the camera and gives them a short course in acting for their own amusement and that of their friends in the audience. A studio in the G.E. building is equipped with a number of television receivers, and camera and transmitting equipment. The receivers are able to pick up all the television programs broadcast in the New York area during the Fair.

The Ford Motor Company shows signs of being television-minded. The television receiver is installed in the executive lounge of the Ford building for the entertainment of guests and as a means of advertising their line of cars. The idea is described as a gesture of courtesy and not as an indication that Ford will enter television manufacturing.

Crosley is staging a large-scale demonstration of facsimile in its New York World's Fair building. The main exhibit is a Crosley Reado, a facsimile printer designed by the Finch Telecommunications Laboratories. Here, visitors hear and see printed matter and pictures transmitted over the kilocycles and recorded on paper at the receiving end.

The RCA exhibit, also, includes facsimile. A similar invention is the radio typewriter, being exhibited by the International Business Machines Corp. This electric writing machine transmits written matter by short-wave from point-to-point with great speed. The exhibit is in the Business Systems and Insurance Building.

From 9 in the morning until 2 in the morning the Public Address Center of the New York World's Fair broadcasts a continuous stream of background music, broken only at intervals with announcements of public interest. The music is of an institutional nature and varies in type and tempo according to the time of day and the section of the ground to which it is directed.

In the General Electric building, visitors can X-ray Harwa, an Egyptian who lived 2,800 years ago, 860 years before Christ. Harwa is now a mummy. By pressing a single button this exhibit is changed from a specially-lighted display of a genuine mummy with its ornate coffin lid standing nearby to a fluorescent image of a skeleton which has been hidden for nearly 3,000 years by the ingenious mummy wrappings applied by the ancient Egyptians for their important dead.

A streamlined lighting maker throws 10,000,000 volts of artificial lightning across a 30-ft. gap in Steinmetz Hall—a part of the General Electric exhibit at the New  
(Continued on following page)

WHY LET THE NEXT FELLOW  
*Cash in on  
the profits*  
SELLING LAFAYETTE P.A.?

**MAKE MORE MONEY!** Profits in P.A. are big today. And the next five years, predict Sound experts, will see Public Address sales soar higher still. Don't let "the other fellow" reap all this profit. YOU can sell Sound! It's easy to install and you can make good money in spare time. And why not sell the line they're all talking—**LAFAYETTE!**

**HERE'S WHY LAFAYETTE**—The P.A. that set the profit pace in '38 is the standout line for '39. For this year, in addition to traditional economy and more-for-the-money value, Lafayette offers Public Address in tune with tomorrow. Completely redesigned, more powerful than ever, and streamlined for sales! 18 years of experienced engineering stand squarely behind Lafayette—born in the world's largest plant devoted exclusively to P.A. Discover how easy it is to sell Lafayette—the big money line!

**LOOK AT YOUR MARKET**—The cafeteria, ball park, theatre, school, plant, auditorium, hospital, business office—wherever people gather in crowds for work, education or play, you can sell Lafayette sound systems. For with Lafayette you have three complete lines to offer, three price ranges—each with its own appeal—"a sound system to meet every sound need." But regardless of price group—Lafayette styling, Lafayette performance and Lafayette economy sell these systems almost on sight!

**ACT NOW!** Get the facts today. Find out how you can make more money selling Lafayette P.A. Tear off coupon and mail at once for full details.



Yes—send me complete information on how to make more money in P.A.

NAME.....  
PLEASE PRINT

ADDRESS.....

CITY.....STATE.....

**LAFAYETTE RADIO CORPORATION**  
Dept. 3FP9-100 Sixth Ave., New York, N. Y.

Please Say That You Saw It in RADIO-CRAFT



**B9**  
Crystal  
**\$22.50**

## D6T DYNAMIC Microphone

A Sturdy, Multi-use, Quality Microphone, with Higher Output and advantageous Directivity Characteristics.

Output level -46, usable range 30-7000 cps.

D6T, High Imp. .... **\$27.50**  
D6, Low Imp. .... **\$25.00**  
Including Cable

*General catalogue describes other attractive models. Request copy.*

**AMERICAN MICROPHONE CO., Inc.**  
LOS ANGELES, CALIF.



**D7T**  
Dynamic  
List  
**\$22.50**



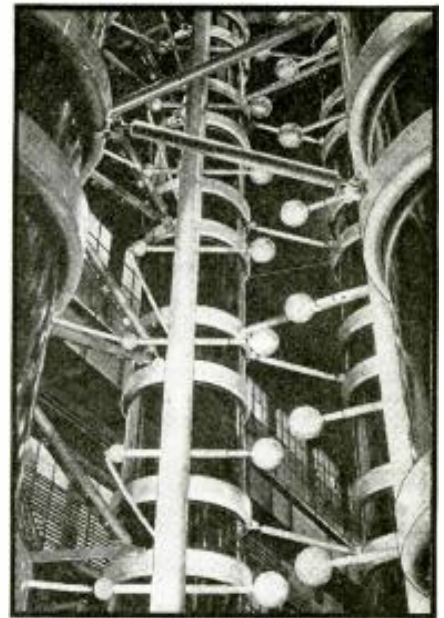

Part of G.E.'s mammoth equipment for generating the 10,000,000 V. artificial lightning demonstrated at the New York World's Fair.

DID YOU SAY 9?

**YOU NEED ALL 9**

# Rider

MANUALS

YES, I SAID 9!

**JOHN F. RIDER, Publisher** 404 FOURTH AVE. NEW YORK CITY

NEWEST addition to Sylvania's line of service helps is an amazing 3-in-1 form which enables servicemen to make out an invoice and guarantee, a job record card, and a follow-up mailing card all in one writing. It's simple—efficient—easy to use—a great time and trouble saver! Send today to Hygrade Sylvania Corp., Emporium, Pa., for free sample—or see your Sylvania jobber.

**LES** Correspondence Courses in **RADIO and ELECTRICAL ENGINEERING**

**ELECTRICAL ENGINEERING** Get good grasp of wide electrical field. Prepare yourself, at Low Cost, for secure future. Modern, simplified, you can understand quickly.

**RADIO ENGINEERING** Extra fine course in radio, public address, photo-electric work, etc. Trains you to be super-service man, real vacuum tube technician. Exper. kits furnished. Diploma on completion. Tuition, \$25. either course. Deferred payment plan.

**FREE** Get copies of school catalogs, student magazines, complete details. **SEND NOW!**

LINCOLN ENGINEERING SCHOOL, Dept 931-C6. LINCOLN, NEBR.

## SAVE MONEY

ON RADIO SETS AND PARTS

SEND FOR OUR FREE GIANT SPRING CATALOG ILLUSTRATING AND DESCRIBING OVER 1,000 MONEY SAVING ITEMS.

**UNITED RADIO COMPANY**  
BOX 1000 NW-NEWARK, N. J.

**R.M.S. MEMBERS and SERVICEMEN**

Sell your customers R. M. S. SUPER COMPACTS (5 tubes). Attractive Prices—Good Discounts. Exclusive Radios for the Serviceman. Write for details.

Send 10c for Philco Parts Catalog

**WILLIAMS PHILCO CO.**  
802 S. ADAMS ST. PEORIA, ILL.

## FILMGRAPH

Newly patented "FILMGRAPH"—instantaneous SOUND-ON-FILM RECORDER and REPRODUCER. No dark room nor processing is required. Special models to make "TALKIES" in conjunction with camera or silent (as well as sound) projectors. Also models for use with or without pictures. 84 minutes of recording (with-out pictures) may be had on a 100 feet of 16 mm. film costing only 85 cents. Permanent PLAY-BACK. Moderate initial cost of FILMGRAPH—only expense for putting SOUND-ON-FILM. MILES REPRODUCER CO., INC., 812-RC BROADWAY, NEW YORK.

## RADIO—AT THE WORLD'S FAIRS

(Continued from preceding page)

York World's Fair. The roar resembles that of real thunder.

The action of every part of a radio transmitter is illustrated by means of a display of 6,400 flashing lights and various colors in the Westinghouse Building in the New York World's Fair. As the visitor steps to a microphone and starts talking, lights swing on and off as different stages of the transmitter are activated. The display was constructed by amateur operators, members of the American Radio Relay League in cooperation with the American Institute and RCA Institutes.

The following miscellaneous items also are of interest to the radio man. Beech-Nut has sound effects synchronized to a circus exhibit . . . G.E. has a 12-ton lightning "bolt"—made by Budd manufacturers of radio towers—129 ft. high . . . The California Olive Association has a Robot Friar that tells about olives . . . The action of artificial fever (diathermy) machines is visualized at one exhibit by a set-up to popcorn . . . The Goodrich auto proving grounds are public-address equipped, including radio and phono . . . Actual experiments can be seen under way in RCA television laboratories on the grounds . . . An RCA color talkie describes transoceanic scrambled speech . . . Another RCA exhibit shows Radio Living Rooms of Today and Tomorrow . . . The Robert Foster "Fountain of the Atom" employs 8 symbolic figures of electrons and protons.

Cosmic rays at the Hayden Planetarium in New York City started the New York World's Fair activities; the fanfare went over a worldwide broadcast hookup.

At the San Francisco World's Fair the Radio-Active Man, one of the radio manifestations of the wizardry of science, is making his first public appearance. The Radio-Active Man imbibes actual radioactive substances from the world-famous University of Calif.'s 225-ton medical Cyclotron. The combination of loudspeaker and Geiger-counter shows exactly where these substances lodge in the body. As soon as the counter is placed in the general vicinity of the ingested substance there is a popping or "clicking" through the loudspeaker. Then the onlookers know that the substance is busy in the heart, lungs or some other organ.

RCA, at the San Francisco World's Fair, practically duplicates its exhibits at the New York World's Fair, described above.

A powerful international short-wave radio transmitter, first ever licensed West of the Mississippi, gives 24-hour service at the San Francisco World's Fair. The transmitter is rigged up in the Building of Elec-

tricity and Communication and is operated by the General Electric Company of Schenectady, N. Y. This 20 kw. station, W6XBE, operates on 2 frequencies. Namely, 9,530 kc. (31.48 meters) and 1,533 kc. (19.56 meters). Its beams are directional to both the Far East and South America.

Millions of visitors at the San Francisco World's Fair are given the opportunity to see for the first time the production and presentation of radio programs. Several times daily these programs are staged, but they never leave the studio for they are arranged only to present the story of broadcasting. Of course there are other radio programs originating at the San Francisco World's Fair which actually get on the air via the networks and local stations.

There is a magic carpet at the San Francisco World's Fair! This display, designed by General Electric does not seem to obey Newton's law of gravity insofar as a 5-lb. aluminum disc is concerned for the disc floats without any discernible means of suspension.

At the San Francisco World's Fair guests see a machine called the Stroboscope which enables one to read printing on a metal disc that spins at the rate of 1,000 revolutions per minute. The machine is a feature of the General Educational Display of the University of California.

A battery of 60 powerful high-fidelity loudspeakers is mounted at 36 locations at the San Francisco World's Fair. These sound projectors deliver a total 3,000 W. of audio power, filling Treasure Island with Theme music and important announcements. The sound system is but one-half the elaborate installation made by the RCA Manufacturing Company. The balance is an immense radio broadcast control center located at the State of California Broadcast and Auditorium Building. Adjacent to the Radio Control Center is a 3,200-ft. broadcast studio believed to be the largest ever built. From this and smaller studios the principal networks broadcast daily programs.

RADIO-CRAFT wishes to express deep appreciation for the cooperation extended by Mr. Frank Zachary in making available in time for this issue the illustrations and detailed description of the revolutionary sound installation at the New York World's Fair 1939.

Please Say That You Saw It in RADIO-CRAFT

## THIS HOME WIRED FOR RADIO

(Continued from page 719)

### THE ARMCHAIR CONTROL UNIT

As shown in Fig. 7 the armchair control unit comprises a Mallory-Yaxley push-button switch and a pilot light. A volume control could not be incorporated without the inclusion of a complicated switching arrangement for disconnecting the "T" pads on the wall panels since it is obvious that any volume control in the armchair control unit would necessarily have to shunt that on the wall panel. However the omission of this control is not a serious handicap because the volume can be pre-set before sitting down.

The wiring of this armchair control unit is essentially the same as that for the pushbutton switches on the speaker brackets, except that the absence of a speaker and "T" pad necessitate only 13 connections instead of the usual 15.

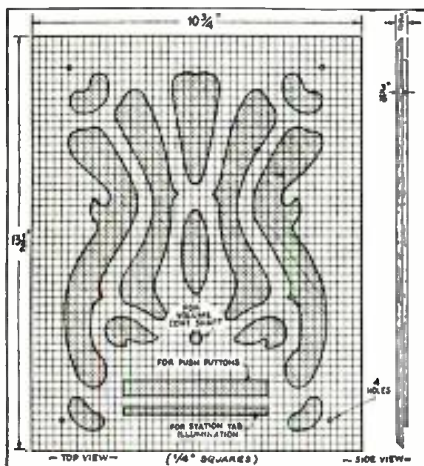

Fig. 8. Working sketch for making the decorative speaker grille.

### MAKING THE SPEAKER GRILLES

In Fig. 8 is a sketch of the speaker grille drawn to scale. It is possible, with the help of this drawing, to make exact-duplicate grilles as used in the "Radio Home." The grilles are made of plywood, 5 plies thick, to guard against warping. Four wood-screws with ornamental heads are used to mount the grilles to the speaker brackets. Behind the grille, reinforced with cardboard backing, is a grille cloth the color and pattern of which may be selected to match the color scheme of the individual rooms. The grilles themselves should be similarly painted or varnished to harmonize with the color scheme or wood trim of the various rooms.

And so, dear readers, we drop the curtain on what has been, we believe, a pioneering development soon to have far-reaching effect on the radio industry. In fact, interest in THE RADIO HOME has now, even before this first series of articles could be concluded, reached quite large proportions. Prospective home owners in the vicinity of THE RADIO HOME, on seeing the outdoor sign, have stopped to inquire about the new radio system—the new money-maker for the Serviceman, dealer, building architect and contractor. Prospective home owners, as well as Servicemen, from widely separated parts of the United States have written-in, requesting modification of the basic plans, outlined in the preceding issues of *Radio-Craft*, to meet individual, local requirements.

Adherents to the old idea, first popularized by the big, progressive hotels, of

being able to select any one of several programs, of course still constitute a reader group of substantial size. But here again *Radio-Craft* has something new to offer, and plans are now underway which will show radio Servicemen and dealers, and building architects and contractors new avenues to substantial incomes, that until now have been dead-end streets.

After all is said and done, however, you have in the series of articles, just concluded, on THE RADIO HOME an almost perfect answer to the question:

"How can I build into my new home a radio system that will give me . . .

- . . . 1) All-wave reception;
- . . . 2) Automatic-record-changing phonograph reproduction (so I will not have to get up from my chair to change records during the playing of a multi-record symphony);
- . . . 3) Instantaneous, pushbutton selection of my favorite stations;
- . . . 4) Selection of stations or phonograph by means of one or more armchair controls;
- . . . 5) High-fidelity reproduction, of radio programs and phonograph recordings, no midjet or mantel set on the approach;
- . . . 6) These facilities of high-fidelity reproduction and pushbutton tuning to be a feature available in every room, plus controls for setting the volume to suit the needs of each room;
- . . . 7) A wiring plan so simple any competent Serviceman can follow it without difficulty, and so flexible it may be adjusted to suit any requirements as to number of rooms to be served, number and placement of speakers and control panels, etc.;
- . . . 8) All wiring to meet Code specifications and, by reducing fire hazards through the use of a system of low-voltage circuits, to assure minimum insurance premiums;
- . . . 9) Initial cost to be commensurate with the size of my pocketbook, and payments to be made, like the payments on the house, on a long-time basis?"

Comments and suggestions from *Radio-Craft* readers concerning THE RADIO HOME are invited. If you are a prospective home-owner, a building architect or contractor, or a radio dealer or Serviceman, and you want any information as to where to obtain any of the equipment specified in this series of articles, or how to modify the design to fit individual needs, or further details on how to get started on a RADIO HOME, *Radio-Craft* will appreciate the opportunity to be of assistance. (Please enclose in your letter a stamped and return-addressed envelope.)

—Editor

### MAJESTIC 850, 750

Loss of volume, together with frying, cracking noises can be traced to 1st I.F. transformer. The primary winding develops a high resistance. Replace with a 456 kc. unit.

L. J. MEYERS,  
Meyers Radio Service Shop

Please Say That You Saw It in RADIO-CRAFT



## VIBRATOR TESTER

Push-Button Type

Model 1671 .. \$41.67 Dealer Net

- Tests All Standard 6-Volt Vibrators
- Easy to Operate . . . Roll Chart Shows Correct Button Settings
- Uses Approved 5000 Ohms Load
- Tester Fused Against Shorted Vibrators
- Flexible Push-Button Switching Permits Placing Proper Voltages on Each Reed, Guarding Against Possibility of Obsolescence.

Triplet Model 1671 will take the guess out of vibrator testing . . . help you locate trouble quicker . . . sell more vibrators.

This new tester has been developed with the cooperation of leading vibrator engineers, and uses the standardized 5000 ohms-8 mfd. load. It will test all standard makes of six-volt vibrators as used in automotive and home battery receivers. The Model 327-A indicating instrument has three scales: 0-10 volts to show input voltage to vibrator for start or running tests. . . . A two-zone, two-color merit scale used in conjunction with the load rheostat shows vibrator condition as GOOD or BAD. . . . A 0-100 scale permits inter-comparison of vibrator outputs under standardized input conditions. A roll chart incorporated immediately below the push-buttons reduces test settings to utmost simplicity. Tester has tip jack facilities for oscilloscope connections. Like provisions have been made for connecting external buffer condensers if desired.

Model 1671 in Standard Triplet DeLuxe Metal Case, 14 1/2 x 7 1/8 x 4 1/2 in. Black Suede Finish . . . Silver and Black Etched Panel . . . Dealer Net . . . . . \$41.67

Model 1671 in Standard Triplet DeLuxe Leatherette Case With Removable Cover and Compartment for Accessories . . . Dealer Net . . . . . \$45.67

Also Available . . . Model 1670 with selector switch controls. In DeLuxe Metal Case . . . Dealer Net . . . . . \$24.00

SEE THE NEW TRIPLET 1939-40 LINE AT THE JUNE NATIONAL RADIO PARTS TRADE SHOW—BOOTHS 403-405



THE TRIPLET ELECTRICAL INSTRUMENT CO.  
166 Harmon Ave., Bluffton, Ohio  
Please send me more information on  Model 1671;  
 Model 1670.

Name . . . . .  
Address . . . . .  
City . . . . . State . . . . .



## FREE CONSULTATION ON AMPLIFIER PROBLEMS

Send that knotty problem to Mr. A. C. Shaney and his expert engineering staff. They will gladly help you solve it in a practical, economical way. No obligation. Simply send full details for prompt, free advice.

Send for **FREE** illustrated CATALOG describing the Only amplifier line **GUARANTEED** for FIVE YEARS.

**AMPLIFIER CO. of AMERICA**

17 WEST 20th STREET NEW YORK, N. Y.

## ANOTHER HOME—WIRED FOR RADIO

This time it's a 4-channel radio system—that is, 4 different programs may be tuned-in simultaneously, in different rooms. By merely turning a selector switch to the proper station mark, any one of 4 programs may be tuned-in from each of the 5 rooms. Further, the system can be turned on and off, and the volume individually controlled, from each of the rooms. By throwing another switch, the speakers may be used as an interphone system. See July Radio-Craft.

Size of box: 12 1/2" x 8 1/2"



Shipping Wt. 3 lbs.

VOGUE

**Pyro Pantagraph**

With this PYRO PANTAGRAPH turn leisure time into profitable hours. Make money a novel, easy way—"Burn Your Way to Extra Dollars with Pyro Pantagraph."

This electrical outfit is especially designed for burning designs permanently on Leather, Wood, Cork, Gourd, Bakelite, etc. Simply plug the Pyro-electric pencil in any 110-volt AC or DC outlet and it is ready to be used. Plug and cord furnished as part of equipment.

By the use of a special Pantagraph included in the outfit, any design may be reproduced either in original, reduced or enlarged form.

Outfit consists of: one Pyro-electric Pencil; one Pantagraph; three hardwood plaques; one bottle of Varnish; one Brush; one tracing tip and four-page instruction sheet.

Outfit will be forwarded by Express Collect if not sufficient postage included with your order.

**WELLWORTH TRADING COMPANY**

558 W. WASHINGTON BLVD., Dept. RC-639, Chicago, Ill.

## RADIO ENGINEERING



RCA Institutes offer an intensive course of high standard embracing all phases of Radio and Television. Practical training with modern equipment at New York and Chicago schools. Also specialized courses and Home Study Courses under "No obligation" plan. Catalog Dept. RC-39.

**RCA INSTITUTES, Inc.**

A Radio Corporation of America Service  
75 Varick St., New York 1154 Merchandise Mart, Chicago

## WEBSTER-RACINE

High Impedance magnetic pickup head. One of the finest pick-up heads made. Head only. Sh. \$1.69  
Wt. 1 lb.  
Webster-Racine arm to fit head Sh. \$1.29  
Unit complete Sh. Wt. 3 lbs. \$2.98  
Send Cash or Money Order, add Postage. Send for our 32 page Bargain Catalog. WE SAVE YOU MONEY



ARROW SALES COMPANY  
619 W. RANDOLPH ST. CHICAGO, ILLINOIS

## TOUCH-O-MATICS

Servicemen — Experimenters — Hams — Radio Clubs. Here is a six button electric tuning unit designed to modernize any car radio. A fortunate purchase enables us to offer these NEW Touch-O-Matics in factory sealed cartons, which formerly sold for \$8.05, now at the AMAZING low price of only \$1.95, plus postage. The component parts, 15 isolating trimmers, 6 volt relay, double band switch, 6 button remote control, shielded cable, etc., adapt themselves admirably to all types of automatic tuning devices. LIMITED SUPPLY. ORDER NOW. SHIPPING WT. 5 LBS. "DEPT.-DR" PARKE RADIO, 1826 N. Springfield Ave., Chicago, Ill.

## EASILY ASSEMBLED "ELECTRIC EYE" KIT

(Continued from page 729)

the cathode and whether the cell is of the vacuum type or contains a small amount of some special gas.

Under ordinary conditions when a piece of photoelectric-active metal is exposed to light, the emission of electrons is retarded by the large atoms of the gases forming the atmosphere. But if the metal is placed in a vacuum and a beam of light is allowed to strike the metal, the electrons will be thrown into the surrounding space. The number of electrons emitted will be proportional to the intensity of the light. The stronger the light, the more electrons will be emitted.

A conductive cell consists of a cathode (already described), and an anode connected to a positive potential and used to attract the electrons emitted. The current intensity will depend to a limited extent on the outside potential and primarily on the amount of light striking the film. Total darkness will limit the current to zero, while very bright light will cause a maximum of saturation current to flow.

While simple circuits are possible and do not require the use of an amplifying vacuum tube, for best results and highest efficiency a vacuum tube should be employed for controlling the relays. By using a tube having extremely high gain it is possible to control the relay action with very small changes in light striking the photocell itself. This is why in the illustrated circuit a type 25A6 pentode has been incorporated. In the output, of course, the relay serves to make or break electrical circuits controlling associated equipment. Counting units may also be connected to the output relay.

### CIRCUIT

Examining the circuit will disclose that the unit is very simple in design and will operate successfully from a 115-volt power line of the A.C. or D.C. type.

The 25A6 tube is employed both as the rectifier as well as the amplifier. The constant bias on the control-grid of this tube depends on the amount of light falling on the photocell and must be adjusted for the most critical point by the use of the 1,500-ohm potentiometer. P. If connected to a source of A.C. power, the unit operates one-half of the time; and the 8 mf. electrolytic condenser across the relay serves to eliminate chatter.

To analyze the action of this circuit, let us consider the action at the point where a positive potential exists on that side of the line which is connected to the relay and screen-grid of the pentode tube. The control-grid of this tube is not biased to a cut-off point; a certain amount of energy will pass through the plate-circuit and activate the relay to a limited extent. The actual bias on the grid will depend on the internal resistance of the photo-tube itself and also on the setting of the potentiometer. This

will be true for any one light condition striking the photocell.

With any one definite light condition existing, potentiometer P may be adjusted so that the plate current is just below the point where the relay will have sufficient energy to pull down the armature. Now if the source of light is reduced at this point, the internal resistance of the photo-tube itself will rise and cause a higher positive potential to be applied to the grid and in turn counteract the negative potential supplied through the drop of the potentiometer circuit. The net rise of the control-grid voltage will cause additional plate current to pass and the armature of the relay will move down to the magnetic pole.

For use under conditions where increase in light intensity is wanted to operate the equipment, the potentiometer is adjusted so that the armature of the relay is just on the verge of rising but is still sufficiently attracted to the magnet of the relay to remain down. With this condition, an increase in light will change the circuit sufficiently so that the plate current will be reduced and the armature will rise.

Since the armature has a contact on each side, it will make another circuit and break the previously-made circuit with any motion. In this manner, associated equipment may be started or stopped with the decrease of light or with the increase of light.

One specific application of the photocell to industry may serve to illustrate just what some of the possibilities are. In the textile industry a common source of difficulty used to occur in testing the colors of materials which had been dyed. In spite of the rigid control, materials which came from the different dye vats did not always match exactly, and it was a rather laborious process to inspect the color of the dyed cloth. In many factories, a photocell installation now takes care of this job. Since variations in color produce variations in intensity of the reflected light, the photocell automatically stops the conveyor belt whenever the cloth of the wrong shade passes by.

In actually assembling the photocell unit illustrated, the builder should be careful to wire the circuit exactly as suggested. The actual placement of parts, however, is not important and for best results the photocell unit itself may be housed to prevent stray light from reaching the sensitive surface. A focusing lens may be adapted to it for concentrating the incoming light on the photocell. This lens should have a focal distance of 6 inches and a diameter of 1 3/8 inches.

Many interesting and instructive experiments can be conducted with a simple kit of this type and it also offers opportunity for the aggressive radio Serviceman to sell equipment of this type for many practical purposes.

This article has been prepared from data supplied by courtesy of Allied Radio Corp.

Please Say That You Saw It in RADIO-CRAFT



# RADIO TRADE DIGEST

## RSA NOTES AND JOTTINGS

(Continued from page 740)

of the Finch facsimile transmission from WLW were passed out and created very favorable comment.

**Holyoke (Mass.) Chapter:** A sketch entitled, "The Work of a Cheap Serviceman," showing the things a Serviceman should not do on a service call, introduced a talk by Bert Taylor, Serviceman and salesman for T. F. Cushing, Springfield, Mass.

**Houston (Tex.) Chapter:** A discussion was carried on regarding cooperation by the manufacturers and the district representatives toward the goal of supplying the membership with more actual data on service, including data on parts used in servicing. It was decided that data on parts and accessories was as important as circuit diagrams.

**Long Island (N. Y.) Chapter:** National Union presented a speaker who discussed the construction and applications of etched-foil condensers.

This chapter is trying a new trick which seems to help attendance. It has a jackpot drawing at every monthly meeting. If the member whose name is drawn is present, he gets the full amount of the jackpot. If not present, he receives a notice that his name was drawn, but not being present, the prize is forfeited and goes to swell the next month's jackpot.

Ed Beatty was the lucky winner of a 'scope in the RCA tube contest.

**Nashville (Tenn.) Chapter:** R. Thomas discussed the progress of a bill now pending in the Tennessee Legislature for the licensing of radio Servicemen.

Earle F. Parker was appointed Secretary, subject to approval of the Special Standing Committee.

**New Hampshire Chapter:** A special meeting was held in order to hear a lecture on volume controls and vibrators by Mr. Arvin of the Mallory Company. It was followed by another special meeting, at which Mr. Potts, of the staff of John Rider, gave a lecture on the Chanalyzer.

A membership drive was also undertaken. The membership was divided into 2 teams, the captains of which are A. K. Harrington and W. Taylor. The losing team is to pay \$1 per man into the treasury.

The advantages and disadvantages of a state license for radio Servicemen were discussed. Peter Pantages was appointed as press representative for Manchester. Homer Sawtelle gave a short talk on an article by Joe Marty, Jr., Executive Secretary of the RSA, pertaining to service costs.

**Steubenville (Ohio) Chapter:** President Harris gave a talk on the noise situation in town, stating that the organization should work together to reveal and eliminate the source of the interference. Plans were made for 2 members to trace it down with directional receivers. Bill Wilson gave a description and explanation of a new electronic tin sorter being installed in the Weirton Steel Company plant.

Members also discussed how to compete with or eliminate the merchants and chain stores that are offering a well-known make of tube to the public at discounts of 40%.

**Washington (D. C.) Chapter:** Professor Reddington of the C.R.E.I., lectured on "Automatic Volume Control." After one hour the speaker stated he had "barely scratched the surface." Joe Marty, Jr., then presented the Chapter with the Charter, and gave a complete history of the RSA, from conception to the present date. Questions regarding RSA were answered.

A Board of Radio Regents was formed, with George W. Cook as Chairman, and W. L. Carey, Nathan Glaser, C. L. Ellis and Al Hines as members. They are to study rules and penalties to enable members to have an accurate check on their own business ethics, and to make the designation "Member RSA" mean something concrete and reliable to the public. A credit reference bureau and an employment agency were also established.

E. B. Reddington of the Capitol Radio Engineering Institute was appointed an Honorary Member for his "services rendered, and keen interest in the Radio Servicemen of America."

Herman Cohn suggested that the local Chapter have slip-under-knob tags printed for distribution to the members to be placed under one of the knobs of every repair job, with an appropriate printed explanation of the member's affiliation with the RSA, and what such membership means to the customer.

**Tulsa (Okla.) Chapter:** A series of television talks is being arranged for group education in television. P. L. Willson took up the various considerations in preparation for the lectures.

The membership of the Tulsa Chapter has had its attention brought to the fact that insurance is a necessary expense. Morris Dundee of Tulsa Radio and Electrical Service was burned out and if he had had no insurance, he would be out of business.

Nineteen Chapters won Rider IX Service Manuals in the 1939 Renewal Dues Contest. Fifteen of these scored 100% renewals, while the winners in the other 4 leagues were all very close to the perfect mark!

The Midwest League of District 10 led the Leagues with five 100% Chapter-teams. The Sunshine League of District 2, with three 100% Chapter-teams was second.

The winners in each league are as follows: Buckeye League, Steubenville, Ohio; Empire League, Binghamton & Jamestown, N. Y.; Keystone League, Johnstown, Pa.; Lone Star League, Houston, Tex.; Midwest League, Alton, Danville, Freeport, Peoria & Rockford, Ill.; National League, Nashville, Tenn.; Northeast League, Holyoke, Mass.; Northwest League, Duluth & St. Paul, Minn.; Sunshine League, Ogden, Utah; Oklahoma City & Tulsa, Okla.; Triborough League, Long Island, N. Y.; Wolverines League, Lansing, Mich.

**Allentown (Pa.) Chapter:** "Present and Future Possibilities of the Serviceman" was the subject of a talk by Sam Harper of the Clough-Brengle Company. Five local jobbers displayed test equipment. Ed Pond was toastmaster.

At a previous meeting, officers for 1939 were elected: President, Kenneth Keck; Vice-President, Thomas Glose; Secretary, H. H. Fillman; and Treasurer, J. A. Muthard. Walter Rees was elected to the Board of Directors.

**Binghamton (N. Y.) Chapter:** Harry Spencer gave a talk on the construction and use of a vacuum tube output meter. He stressed its ability to work with a very low signal input.

Eddie Donnelly presented a device which gives an audible indication of a cut-off in an intermittent receiver, when connected to R.F., I.F., or audio circuits. Members tried to fool the thing, but no go.

**Boston Chapter** was addressed by R. Perron of Clough-Brengle, who spoke on "Dynamic Testing of Radio Sets."

Member Raymond Wyman gave a talk on tubes, using a display numbering hundreds of tubes, from the earliest diodes to the latest multi-purpose tubes. It was the first of a series, with a different member to speak each time on a branch of radio service technique.

**Bridgeport (Conn.) Chapter:** P. Stern gave a talk on "cut-throat" prices and its possible cure. A committee to investigate claims of "cut-throat" practices was appointed: J. Durante, P. Stern and B. Stern.

Arthur Hatton, engineer of Electrical Apparatus Company of Boston, spoke on "Ceramic Capacitors" (condensers).

A communication from the Executive Secretary of RSA presenting Chapter's Charter was read and accepted. A membership talk by the president culminated in the signing of 5 applications, with more to follow at next meeting. J. Gompertz gave a very interesting talk on a new type of television antenna to be used at the World's Fair. He also told of new test equipment needed to service television sets.

**Chicago Chapter:** George Devine of G. E. discussed the Armstrong system of frequency modulated transmission, and its theory of interference elimination. Another feature was his thorough discussion of the Faraday shielded loop antenna and its application in present-day receivers.

At an exceptionally well attended meeting, Chief Engineer D. von Jenef of Million Radio and Television Laboratory, introduced the Signalizer as the latest addition to the line of channel testing equipment.

# SPRAGUE ATOMS

"Highest Midgets of All"

## NO OTHER MIDGET BRINGS YOU SO MANY FEATURES

More honest-to-goodness features — smaller size — at the lowest possible cost! That is the story of Sprague ATOMS, the amazing midget dry electrolytic condenser development.

ATOMS are the smallest midgets on the market. They build up to higher surges than any similar units. They have lower leakage and power factor. They're unconditionally guaranteed against blow-ups. They're made in more capacities, more voltages plus a complete line-up of dual capacity units with common negative leads. Self-supporting. You mount 'em like paper tubulars. You use 'em for any replacement where you want real efficiency, smallest size, lowest possible cost.

### HANDY KITS

Sold singly or in handy kits of 6 or 12 condensers. Write for complete Sprague Condenser Catalog.



**SPRAGUE PRODUCTS CO.**  
North Adams, Mass.



### UNIVERSAL 15MM. "Streamliner"

Highest quality sound pickup for p. a., recording and amateur. Crystal or dynamic in any impedance. Modern in design. Incl. loop, flex tube, screw plug and 25 ft. cable. In De Luxe package. At your jobber's now.

**UNIVERSAL MICROPHONE CO., LTD.**  
424 Warren Lane, Inglewood, Calif.

## BUILD YOUR OWN RADIO

**ANYONE CAN DO IT!**  
It's easy! Just follow our simple instructions and plans. Results guaranteed! Write for full particulars.



**X-L ENGINEERING CO.**  
2337 Grand River Detroit, Mich.

## OLD PHONOGRAPH RECORDS

### WE BUY THEM

Dig them up and ship to us. Classical or popular. Victor records. Check sent the day records are received. We pay express charges.

**MODELL'S, Dept. 269, 68 Cortland St., N.Y.C.**



**EVERYTHING IN RADIO!**  
A COMPLETE SOURCE FOR YOUR RADIO NEEDS. Our immense stock of radio sets, parts and supplies enables you to purchase your entire needs on one order. You will find all your Nationally Known Favorites in this big book which is FREE for the asking. Practically every order is shipped the same day it is received. WRITE FOR BIG NEW CATALOG

**BURSTEIN-APPLEBEE CO.**  
1017-14 McGee St. - Kansas City, Mo.

## QUALITY ADAPTORS AND SOCKETS FOR CHECKING NEW LOCAL TUBES!



Dependable sockets and adaptors are more important than ever before because of the increased demands on the octal and loctal tubes.

NAARD Patented Parallel Precision Contacts are designed to withstand severe abuse, having passed tests of more than 1,750,000 repeated insertions without contact failure. Insist on NAARD Sockets and Adaptors for quality. Place your order with your jobber, or direct, stating what checker or analyzer you are using.

**ALDEN PRODUCTS CO., Dept. RN-C5, Brockton, Mass.**

Please Say That You Saw It in RADIO-CRAFT



# RADIO TRADE DIGEST

**Cleveland Chapter:** New officers are: Chairman, Alex Plakadis; Vice-Chairman, Ed George; Secretary, Thomas Holmes; and Treasurer, Nate Dishler. All are top-notchers.

**Danville (Ill.) Chapter:** L. S. Hicks of the RSA Speakers' Bureau spoke on "Transformers in Service."

Owen McArdle took charge of the instruction end of the program to present "Inverse Feedback" at a subsequent meeting.

**Decatur (Ill.) Chapter:** Last meeting was devoted entirely to criticisms and personal suggestions as to exactly what each member expected and hoped to receive from RSA. Everyone was urged to unload whatever might be on his chest. In the end, it was pretty clearly understood that just a few members could not accomplish much without the wholehearted cooperation and the regular attendance of every member.

Chapter decided to invite advertising specialists to speak, and plans to distribute printed circulars over the entire city.

**New Jersey Chapter:** Carl Rauber, Director of our District, gave a talk on and led a discussion of Television at our meeting of February 11th. Mr. Gnadinger donated mimeographed copies of a treatise on "Vacuum Tube Voltmeters." Each member received a copy.

**New York Metropolitan Chapter:** Some 300 men attended a meeting at which William M. Bailey spoke on paper and Dykanol condensers; Stanley Walters covered wet and dry electrolytics, and their applications and characteristics; and Frank Taylor showed pictures of a condenser plant in operation. All of the speakers were from the Cornell-Dubilier organization.

**Jamestown (N. Y.) Chapter** held their annual mid-Winter banquet and installation of officers. Fred Beaumont of Jamestown and Buffalo presided as toastmaster and installed the new officers: President, Richard Bonsteel; Vice-President, Larry Lodestro; Secretary, Lawrence S. Babcock; Treasurer, C. Leonard Johnson. Our officers responded with a brief talk.

Mr. Beaumont then introduced William Hake of the Retail Merchants' Association of Jamestown. Mr. Hake outlined the plans of that Association and asked the cooperation of the radio Servicemen.

The principal speaker of the evening was Mr. Potts of Service Instruments, Inc.

**Jamestown (Pa.) Chapter:** Joseph Marty, Jr., Executive Secretary of the RSA, presented an interesting and educational talk on the history, organization and plans of the RSA. Members of the Chapter tendered a dinner in Marty's honor. Those in charge of the affair were Ralph Galasso, D. L. Kaufman, Kenneth Vaughan, George W. Martin, J. T. Noll, Joseph E. Gerber and R. J. Emmerling.

**Lansing (Mich.) Chapter:** Leland S. Hicks of the RSA Speakers' Bureau gave a talk on "Transformer Applications for Radio Servicemen." The speaker illustrated his talk, and followed it by a period of questions and answers.

**Oklahoma City Chapter** voted to reduce the local dues to \$1 annually and put on a membership drive.

It was also voted to reduce the number of business and technical meetings from weekly to 2 per month. One social meeting per month will be arranged by the Program Committee.

**Pittsburgh Chapter:** "Idle Time—What It Costs" was the subject of a talk by Bert A. Brengener. A general discussion of receiver case histories followed the regular meeting.

**Pontiac (Mich.) Chapter:** Leland Hicks of the RSA Speakers' Bureau gave a talk and blackboard discussion on transformers. Attendance was fine despite an ice storm that stopped traffic for a time.

Joe Cole, Director of the district, spoke on "Bookkeeping Methods and Records." He showed expense, time and profit charts and ledger pages.

**Quincy (Ill.) Chapter** elected the following officers for 1939: President, Dwight Peters; Vice-President, H. A. Wenzel; Secretary, Gale Venghaus; Treasurer, Elmer Hagenbaumer.

The Chapter decided to eliminate compulsory price maintenance by members, as this caused considerable friction within the group. Plans for increased activities and interest were made.

**Springfield (Ill.) Chapter:** Minimum prices and local interference elimination were discussed. Gene Parish was appointed chairman of the Public Relations Committee.

**St. Joseph (Mo.) Chapter:** Election of officers for 1939 found Cleo Blodgett, President; Oliver Parsons, Vice-President; Russell Goerke, Treasurer; and Jack Abercrombie, Secretary. Jack Abercrombie gave the talk of the evening. His subject was "The Decibel System."

**St. Paul Chapter:** A disassembled Philco condenser was shown to the group, and a discussion followed.

Charles W. Fox spoke on "Resistance and Current Distribution."

**Westchester (N. Y.) Chapter:** M. B. Sleeper of F. A. D. Andrea Radio Corp. discussed the great improvements made in the transmission and reception of television in recent years. About 100 men attended.

The special coding of receivers by members of RSA will be brought up for adoption at the next meeting.

Henry Lutters, director from the Westchester district, is busy forming a new Chapter in Stamford, Connecticut.

**Williamsport (Pa.) Chapter:** Joe Marty, Jr., Executive Secretary of RSA, presented the Charter and discussed the value of RSA. Marty also gave advice on how to conduct the Chapter.

## SNOOPS & SCOOPS

(Continued from page 741)

200 spellbound Servicemen heard Gerald DeNike, Natl. Union adv. mgr., in a talk on advertising methods for Servicemen. . . . Western Electric is installing the radio-phone eqipt. on the tankers S. T. Kiddoo & Verdon for Spentonbush Fuel Co. . . . Consolidated Wire has a new line of volume & tone controls, whose 5 models will take care of 90% of all replacements.

Hickok tube tester models Nos. 51-X, T-35-P, T-53-C & 5348 now test Octals, ballasts, 50-V. tubes, & pilot lights—& include a noise tester. Bulletin 10 tells all. . . . New smaller hi-efficiency 1½-V. Burgess "Little 6" batteries have higher working voltage than old No. 6's. . . . Federated Purchaser, N. Y., now has a truck delivery service within a 30-mi. radius.

Thordarson's new T-13R19 midget replacement power transformer mounts in 3 positions; delivers 480-V. C-T. @ 40 ma., 5-V. @ 2 A., 6.3-V. C-T. @ 2 A. . . . IRC has introduced low-power w-w controls in all needed ranges up to 10,000 ohms. . . . Stewart-Warner releases replacement code on Ken-Rad & Raytheon tubes, with note that defectives are to be returned direct to mfr. & not to S-W.

The NAB will meet at the Hotel Ambassador, Atlantic City, N. J., July 10-13 for its annual convention. . . . Pierce-Airo, N.Y.C., & Kolorama Labs., Inc., Irvington, N.J., have applied for R.M.A. membership. . . . Patent 2,149,136 has been granted to W. G. H. Finch for his new methods for increasing the efficiency, and reducing the cost and complexity, of drum-drive scanning systems.

### Ready for Service

RCA is readying a line of service apparatus for telly. (See pix, page 740.)

Crosley Corp. and Don Lee Broadcasting System both have applied to FCC for permits to construct 1 kw. telly stations.

BBC telly production manager, Donald Hunter Munro, will spend several weeks as consultant to Gilbert Seldes, CBS telly program director.

NBC is dickering with movie moguls for telly rights to movie features. A telecast of F. D. R. will inaugurate NBC's service.

DO MAJOR EXPERIMENTING WITH THE NEW RADIO

# FACSIMILE PRINTING



**BUILD IT YOURSELF**

**CROSLEY READO KIT \$49.50**

Radio in its infancy did not promise as much as FACSIMILE RADIO PRINTING does today. Licensed under the Federal Communications Commission, leading broadcasting stations are broadcasting experimentally late every night on the broadcast bands and in some instances during the day on high frequencies. **BE FIRST IN THE FIELD** Now is the time to get in on the ground floor either for future profit or present pleasure. It is a new art already developed to a fascinating degree through daily experimental broadcasts of WOR, WLW and others. It bids fair to be the most important of all radio developments—a not too distant future should see radio facsimile printers in every home, unrolling a constant strip of pictures, news, vital statistics and reports in a steady stream. Grow with the art. Build your own facsimile printer with the Crosley Reado Kit.

Get in on the development. Radio Amateurs will soon be exchanging their pictures by radio.

TRADE PICTURES WITH OTHER HAMS The READO radio printers kit is complete with all parts precision machined. Full details of construction are furnished. If a Crosley dealer handling this kit is not convenient write

**THE CROSLEY CORPORATION**  
READO DEPARTMENT POWEL CROSLEY, Jr., Pres.  
111 ARLINGTON STREET CINCINNATI, OHIO

Please send me literature about the Crosley READO, all facsimile broadcasting activities and list of stations now doing experimental broadcasting. Also, the name of my nearest Crosley dealer to carry the Reado Kit.

**USE THIS COUPON** NAME.....  
ADDRESS.....

### TWENTY-FIVE BIG OFFERS!

The Classified Section which appears on Page 767 contains many interesting offers and services. **TURN TO IT NOW . . . READ IT FROM START TO FINISH!**

## CREI Spare-time Training Leads You to a Better Job

CREI Home-Study Training Prepares You for a Bright Career in Practical Radio Engineering!

Don't "sit-down" on the job! Get busy and prepare yourself for the bigger jobs in store for technically trained men. CREI offers home-study training in Radio Engineering and Television. A post card brings you our 48-page book of interesting facts about your future in Radio—and how we can help you prepare for it.

**SEND FOR FREE CATALOG**

**CAPITOL RADIO ENGINEERING INSTITUTE**  
Dept. RC-6, 3224-16th St., N.W.  
WASHINGTON, D. C.



Please Say That You Saw It in RADIO-CRAFT

# Learn RADIO

with *Quirardi's* Home-Training Course  
**COMPLETE IN 7 BIG BOOKS**

Here is your BIG CHANCE to get into RADIO! This ONE handy volume gives you the complete fundamentals of Radio, Electricity, Television, Sound and Cathode-Ray Tubes—the same course used by more radio schools and students than any other radio book in the world. Think of it!—for \$4 you too can thoroughly equip yourself for a lifetime radio career!

**EASY AS A. B. C.**  
 It's a pleasure to learn radio this way! Everything is made clear and simple—practical short-cuts speed your training. No math—no previous training necessary!

**36 VOLUMES IN 1—972 PP.—508 ILLUS.**  
 1. Radio Broadcasting System. 2. Sound, Speech, Music. 3. Electron Theory. Elec. Current. Elec. Units; Ohm's Law; Resistance. 4. Elec. Circuits. Batteries. 5. Magnetism. 7. Electro-magnetism. 8. Electromagnetic Induction. 9. Inductance. 10. Capacitance; Condensers. 11. A.C. Circuits. 12. Filters. 13. Measuring Instruments. 14. Radio Waves. 15. Broadcasting. 16. Receiving. 17. Vacuum Tube Principles. 18. Vacuum Tube Characteristics. 19. Vacuum Tube Construction. 20. Vacuum Tube Detector and Amplifier Action. 21. Radio Frequency Amplification. 22. Superheterodyne. 23. R.F. Amplifiers; Tuning Coils. 24. Audio Amplifiers. 25. Speakers. 26. Battery Operated Receivers. 27. Power Supply Units. 28. Elec. Servicers. 29. Automobile and Aircraft Radio. 30. Phono Pickups; Sound Systems. 31. Short-Wave. 32. Photoelectric Cells; Cathode-Ray Tubes. 33. Television. 34. Antennas and Grounds. 35. Testing; Servicing. 36. Sound Films. 368 Self-Review Questions!

**USE IT 5 DAYS—OUR RISK!**  
 Yes, if you can part with the book after 5 days, return it and get your money back. No risk—no trouble—just clip the coupon—and mail it NOW!

**MAIL COUPON TODAY**

Radio & Technical Publishing Co.  
 45 Astor Place, New York, Dept. RC-89.

Here is my \$4. Please send RADIO PHYSICS COURSE postpaid, with money-back guarantee.

NAME .....  
 ADDRESS .....  
 CITY ..... STATE .....

Send free descriptive literature.

## YOUR LAST OPPORTUNITY TO GET THIS FREE BOOK!

Only a few copies of the RADIO REFERENCE ANNUAL are still available! It's the BIG FREE BOOK of 64 pages you receive when you subscribe to RADIO-CRAFT. The ANNUAL covers set building, servicing, public address, test equipment, plus a number of other interesting topics. Send your remittance of One Dollar to RADIO-CRAFT, 99-R HUDSON STREET, New York, N. Y., and you will receive a subscription to RADIO-CRAFT for Seven Months, and your copy of the RADIO REFERENCE ANNUAL will be mailed postpaid immediately.

## FREE AMPLITONE

*New 1939 Sound Catalog*

Illustrating our complete line of modern sound equipment.

Write for your FREE copy NOW!

**AMPLITONE PRODUCTS CO.**  
 135 Liberty St. New York City, N. Y.

## ELECTRICITY

FROM YOUR OWN ELECTRIC PLUG WHEN POWER LINES FAIL

ONAN A.C. ELECTRIC PLANTS supply current for Radios, Transmitters and Receivers, P. A. Systems, Movie Projectors, Sound Truck Apparatus, Tolls, Lights, All Appliances. Used as Standby Equipment in Schools, Hospitals, Theaters and Public Buildings in case of Power Line Failure due to Storms, Floods, etc. Available in 110 or 220 Volt A.C.—12, 32 and 110 Volt D.C.—Also Dual Voltage A.C.-D.C. Types. Manual, Full-Automatic & Self-Starting. \$79 and up. Shipped, Ready to Run.

**D. W. ONAN & SONS**  
 683 Regent Avenue Minneapolis, Minn.

## PATENTS—TRADE MARKS

Booklet concerning Inventions & Patents Form "Evidence of Conception" with instructions for use and "Schedule of Government and Attorneys Fees"—Free

**LANCASTER, ALLWINE & ROMMEL**  
 Registered Patent Attorneys  
 436 Bowen Bldg. Washington, D. C.

## RADIO COURSES

New Fall Classes Start in September  
 RADIO OPERATING—BROADCASTING

- RADIO SERVICING — a practical course
- RADIO AMATEUR CODE ● TELEVISION
- ELECTRONICS—1 yr. day course 2 yrs. eve. Day and Evening Classes. Booklet Upon Request.

**New York Y.M.C.A. Schools**  
 4 W. 64th Street New York City

# RADIO TRADE DIGEST

## BUSINESS PREPARING FOR BOOM AS TELEVISION MAKES ITS BOW

(Continued from page 739)

also dickering with Hotel Lincoln, New York City, with view to similar installation. Ian Javal, commercial director of Baird, British telly co., is in New York to help Baird Tel. Corp. of Amer. get going. Baird Co. is figuring on selling to theaters as well as Old Gen. Public.

area, why not make up a 5-man team & enter? Attend anyway; noted speakers will tell you things you never knew before.

## \$'s & No.'s Dept.

(Continued from page 742)

CANADIAN RMA also reported better biz in Jan. '39, though not as much up as in U.S. Sales of sets there were \$987,959—or up about 17%.

THOUGH Stewart-Warner Sales dropped \$294,323 in 1938, the organization looks firmer than ever from latest statement which shows ratio of assets: liabilities as 4.89:1, compared with 2.83:1 at end of '37. Its radio line was off 48%, but bank loans of \$1,600,000 were paid off & cash reserve increased \$425,353.

## OFF THE PRESS

(Continued from page 742)

### PUBS LOCATIONS

1939 CATALOG (2nd Edition). Hammarlund Mfg. Co., N.Y.C. 20 pp. Lists many new parts, including shortwave components; gives electrical & mechanical data.

RCA RECEIVING TUBE CHARACTERISTICS CHART 1275-B. RCA Mfg. Co. Harrison, N. J. 16 pp. Contains all essential information on over 200 RCA tubes.

MORE stations join NBC nets, the total at press time being 172.

BILLINGS at NBC zoomed to 7.2% over preceding year, according to Feb. figs., the take being \$3,748,695.

RCA SUMS UP for 1938, & finds NBC time sales 4% over '37; RCA Mfg. Co. net profit up 11%.

PRACTICAL APPLICATION OF THE OSCILLOGRAPH. Spokane Radio Co., Spokane, Wash. 16 pp. Explanation of use of this important instrument.

CATALOG SHEET SF-1. Western Labs., Milwaukee, Wis. 4 pp. Descriptions of new sound equip't.

EVERY mo. in '38 showed a profit for Westinghouse, though volume of orders was 35% down from '37. Sales billings were off only 23%.

CAPACITORS CATALOG No. 161. Cornell-Dubilier Elec. Corp., S. Plainfield, N. J. 40 pp. Prices, descriptions & specs. of great variety of fixed condensers.

## SALES HELPS & DEALS

(Continued from page 742)

PHOTOELECTRIC CELLS, MODEL 594, TYPES 1 & 2. Weston Elec. Inst. Co., Newark, N. J. 4 pp. Description, prices & specs. for several mountings of these models.

Sylvania offers a swell job record card, customer invoice, & guarantee, put up 25 to a pad. Price with dealer's imprint, \$1.50 for 100 sets to \$4 for 500 sets. (See illustration, page 740.)

1939 CATALOG. Atlas Sound Corp. Brooklyn, N. Y. Lists speakers, horns, baffles, mike stands, etc.

ATR CATALOG 139. Amer. Television & Radio Co., St. Paul, Minn. 8 pp. Prices, descriptions & specs. of vibrators & power supplies.

## PERSONALS

(Continued from page 742)

CATALOG SHEET. D. W. Onan & Sons, Minneapolis, Minn. 2 pp. Description, specs. & prices of new 1,500-W. electric plants in manual starting, self-starting & fully-automatic models.

of tool planning and wage rate at G-E's Phila. plant, has been made sup't of the works. He's been with the co. since 1919.

PATTERN 20 TUBEMASTER. John Meek Instruments, Chicago, Ill. Prices, descriptions, etc., of models 20 & 20-A tube testers. Tells what to look for in design.

GEORGE MALSED replaces George Ewald as district sales mgr. at Dallas, Tex., for RCA-Victor. Ewald goes to Camden. (See picture, page 741.)

RIDER CHANALYST. Service Insts., Inc., N.Y.C. 80 pp. Description of & operating instructions for this famous test instrument. Well illustrated, & useful whether one owns the tester or not. Price 25c from manufacturer.

HAROLD WINTERS takes over same job at Kansas City for same co., replacing Dale Neiswander, who left to become gen. mgr. of Interstate Supply Co., St. Louis.

## Telly Sets for FCC

Inspired by a newspaper statement that the Federal Communications Commission "won't be stamped blindly into launching the television industry," F.A.D. Andrea had his advertising agent wire FCC Commissioner McNinch.

FRANCIS H. ENGEL has been given the task of coordinating and planning development of RCA television receivers.

The wire read, "In order facilitate work of FCC in study of television for possible commercial broadcasting and to demonstrate quality of reception from production receivers, Andrea Radio Corporation will be pleased to place required number Andrea television receivers at disposal members of committee without charge at any point within radius of transmitters being tested."

J. A. MILLING, ex-mgr. of parts sales, has been made mgr. of same co.'s small radio division.

In this way Mr. Andrea gave concrete proof of his faith in the new industry.

DONALD A. WOOD succeeds R. W. HART, resigned, as mgr. of the adv. service division of G-E's appliance & merchandise dept.

FLASH—Rochester—Radio Technicians Guild will hold an all-day educational meeting on May 28. Theme is "Good Fellowship." Servicemen within 300 mile radius & from New England will attend. A Technical Quiz will test the knowledge of participants. If you live in the

NORMAN B. NEELY planned & installed the speech & recording equip't in the new Huntington Park (Calif.) studios of KFOX for Don Irwin.

BILL STANCIL & RICHARD HIX have joined Neely as sales engineers. Bill will handle field work in recording, radio, & movie work; Dick is a television specialist.

Please Say That You Saw It in RADIO-CRAFT

## RADICALLY NEW! COMBINED PHOTOCCELL-RELAY

(Continued from page 729)

### PRINCIPLE

The operating principle is novel and very ingenious. Variation in gas pressure under the catalytic influence of light is the physical effect used, instead of using electronic emission as in ordinary photocells.

It is known that chlorine and hydrogen have a great affinity for each other and that their combination, which produces hydrochloric acid, may develop considerable heat. When the gas mixture is exposed to direct sunlight, the rate of combination may be controlled by the intensity of the light (and particularly the ultra-violet radiations).

For example, direct sunlight catalyzes the gases suddenly, giving rise to a large evolution of heat and intense gas expansion resulting in an explosion. Diffused light, however, causes only partial combination and therefore no explosion, while in darkness the gases do not combine.

Reversing the process of combination, chlorine and hydrogen can be liberated from a solution of hydrochloric acid by electrolysis, that is, passing a current between 2 electrodes immersed in the liquid.

Hydrogen is liberated at the cathode and chlorine at the anode. If the electrolysis occurs in a closed vessel the liberation of the gases develops a considerable gas pressure within the vessel.

Since hydrogen is insoluble in water, and the solubility of hydrochloric acid is much greater than that of chlorine, it follows that the combination of the gases when illuminated decreases the gas pressure; while in darkness the gas pressure is maximum.

### PRACTICE

In the Chilowski light relay, the changes in gas pressure depress or relax a diaphragm and thus vary the air pressure in an adjoining tube of mercury. The changes in the level of the mercury in a U tube closes one circuit and opens another as shown in Fig. 1A at H and K. In Fig. 1B the light rays reaching the gases in A cause their combination and absorption by the liquid solution. The gas pressure decreasing, the liquid rises in A, reducing the disten-

tion or bulging of the diaphragm C, the mercury then rises at E and thus opens the circuit between G and H.

In darkness, the hydrochloric gas pressure is high, the diaphragm pushes the air in D, the mercury rises at G and closes the contacts for the circuit of the lamp and battery.

### CONTACT K

The use of contact K will now be explained: the current from the negative pole of the battery flows to one of the electrodes immersed in the acid through a 1,500-ohm resistor, while that from the positive flows to the other electrode through the mercury in the U tube, the 1-megohm resistor being short-circuited when there is no pressure on the diaphragm.

When the pressure on the diaphragm rises and the level of the mercury at E falls, K is disconnected and the current to the electrodes in the acid flows through the 1-megohm resistor.

The small current produces sufficient electrolysis to maintain the gas pressure in the bulb and thus the main circuit is kept closed. This feature is desirable because were it not for this provision the pressure would gradually fall owing to the absorption of some of the gases by the solution, and the relay would only interrupt the lamp circuit rapidly.

The Chilowski relay is used in the Tubest automatic car parking light control apparatus, the object of which is to switch on automatically the parking lights, of a car left unattended, when darkness falls.

Certain of the French railway systems have been equipped with Chilowski relays with entirely satisfactory results.

This new type of light-controlled relay should become popular on account of its simplicity, compactness, lower cost of installation, and its power-handling capacity, which is about 250 watts for a single bulb.

The rear-view photo, pg. 729, shows the relay in its box, with the bulb, resistors and connections for wiring. The controlling light received reaches the gas in the bulb through a glazed window at the top of the apparatus.

## The HOW, WHY, WHEN, and WHERE of Service Work

### MODERN Radio SERVICING

**FUNDAMENTALS  
made Plain!**

This is the book to give you the "How" and "Why" of radio service work—everything you need to learn about present-day testing and repairing—the theory, the methods, the equipment—complete and compact in one big home-study book. Take Girardi's quick, easy way to benefit from the practical experience of the country's leading servicing organizations.

- Test Equipment—Theory, Descriptions, Diagrams of all Commercial Instruments, How They Work, Construction Data, etc.
- Trouble-Shooting—Newest short-cut methods for even the most complicated receivers.
- Repairing—Advanced "Factory-Methods" for Repairing all Parts, explained fully.
- Special Problems—Servicing All-Wave, High Fidelity "Intermittent", Auto-Radio Sets, etc.



1300 PAGES \$4  
706 ILLUS.

### RADIO Trouble-Shooter's HANDBOOK

**Practical  
JOB DATA!**

Here, at last, in one handy reference book is the indispensable data you need on service jobs when and where you want it. No fumbling—no fumbling—no time-wasting—Girardi gives it to you in a flash. It's the only book of its kind. Don't be without it!

- 3,313 Case Histories—Trouble Symptoms and Remedies compiled from actual Service Records.
- I-F Peaks—Over 15,000 Listings for Alignment of all Superhets.
- Other Data—Auto-Radio Data for Installation, Interference Elimination, etc., Trouble-Shooting Charts; Servicing Intercommunicators; Trade Directories; Tube Data; and dozens of Charts and Tables.

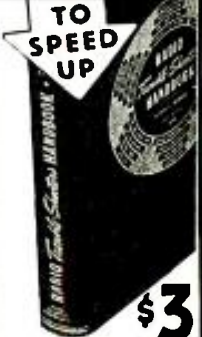

318 PAGES, 134 ILLUS., Standard Magazine Size. (8 1/2 x 11). Fabrikoid-bound. \$3

### USE THEM 5 DAYS—our risk

Return them if not satisfied

**MAIL NOW!**

Radio & Tech. Publ. Co.  
45 Astor Pl., New York, Dept. RC-69

Enclosed find payment for:

MODERN RADIO SERVICING

RADIO TROUBLE SHOOTER'S HANDBOOK

BOTH books at \$8.50 Special Combination Price

NAME: \_\_\_\_\_

ADDRESS: \_\_\_\_\_

CITY: \_\_\_\_\_ STATE: \_\_\_\_\_

### DIRECT-COUPLED AMPLIFIERS ARE NOT TRICKY! . . .

Nor are they unreliable, or expensive, or hard to understand. A. C. Shaney, in an enlightening article especially written for *Radio-Craft*, discusses the fundamental theory, design principles, and construction of an up-to-date direct-coupled pushpull 10-W. amplifier. According to Mr. Shaney it's as simple as A-B-C—and he proves it to you. Get all the details in the July issue of *Radio-Craft*—reserve your copy now.

### YOUR FUTURE IN RADIO TELEVISION

These growing industries need trained men for sales, service, operation. Your chance for employment and advancement depends on thorough training. National Schools offer you time-tested training. Complete, modern facilities and equipment in the largest trade school in the West. Established 1905.

### NATIONAL SCHOOLS

4000 S. Figueroa Street, Los Angeles

NATIONAL SCHOOLS, Dept. 6-RC, Los Angeles

Please read free Radio and Television Booklet.

NAME: \_\_\_\_\_ AGE: \_\_\_\_\_

ADDRESS: \_\_\_\_\_

CITY: \_\_\_\_\_ STATE: \_\_\_\_\_

## FREE TRIAL OFFER

NEW REMINGTON NOISELESS PORTABLE!



AS LITTLE AS  
**10¢ A DAY**

Famous Remington Noiseless Portable that speaks in a whisper. Pay as little as 10¢ a day. Guaranteed by the factory. Standard keyboard. Automatic ribbon reverse. Variable line spacer and all the conveniences of the finest portable ever built. PLUS the NOISELESS feature. Act now. Send coupon TODAY for details.

#### You don't RISK a Penny

We send you Remington Noiseless Portable for 10 days' free trial. If not satisfied, send it back. We pay all shipping charges.

#### Typing Course and Carrying Case

You will receive FREE a complete simplified home course in Touch Typing, a handsome sturdy carrying case is included. No obligation. Mail coupon for full details—NOW.

Remington Rand, Inc., Dept. 189-6,  
445 Washington St., Buffalo, N. Y.

Tell me, without obligation, how to get a Free Trial of a new Remington Noiseless Portable, including Carrying Case and Free Typing Course for as little as 10¢ a day. Send Catalogue.

Name: \_\_\_\_\_

Address: \_\_\_\_\_

City: \_\_\_\_\_ State: \_\_\_\_\_

### Feature Articles in the Special June Television Number of "RADIO & TELEVISION"

- How N.B.C. Television Evolved—by O. B. Hanson, Chief Engineer, N.B.C.
- C.B.S. Television Atop 80-story Building—by Dr. Peter Goldmark, Chief Television Engineer, C.B.S.
- Opportunities in Television—Studio, Servicing, Engineering—by Dr. Alfred N. Goldsmith.
- How to Build a Television Receiver—by Robert Eichberg.
- De Luxe "Beam Power 3" Transmitter—by Howard G. McEntee, W2FHP.
- 2½, 5 and 10 Meter Superhet.—by Herman Yellin, W2AJL.
- Best "Short Wave Station" List International Radio Review.

Please Say That You Saw It in RADIO-CRAFT

## \$4,000 P. A. CONTEST

(Continued from page 722)

installation and to emphasize the fact that ANY radio man can engage in this profitable activity, *Radio-Craft* has instituted this contest.

There are no strings attached—anyone with the ability to make a public-address installation is eligible. The contest rules are explained below.

*Radio-Craft* feels that many individuals and organizations have made public-address installations introducing equipment or set-up innovations, or employing P.A. apparatus, which meet entirely new and novel conditions; or other worthwhile P.A. installations. Therefore, in order to give our readers first-hand information we plan to run a series of articles based on the winning entries of this contest.

In order that these may be the cream of public-address installation articles, valuable awards are being given each month, for four (4) consecutive months. These awards will be made available through the co-operation of well-known manufacturers of public address and sound equipment.

For this reason, every Serviceman, dealer, public-address specialist or group of specialists capable of making what may be considered a worthwhile public-address installation will find it profitable to enter this contest.

### Contest Rules

#### Section No. 2 (June)

- (1) Write a letter of not more than five hundred (500) words, exclusive of list of components, describing in detail a practical public-address installation.

- (2) Outline in the letter the business angle of the deal:
  - (A) How and where you got the lead, how you followed it up, and how you clinched the sale.
  - (B) Cost of apparatus, sale price, profit involved. In fact, give all the details which will guide other men in the radio field in undertaking similar work.
- (3) Outline the technical angle of the deal:
  - (A) Purpose of installation.
  - (B) Technical problems involved.
  - (C) Choice of equipment and reasons for use of same.
  - (D) How installation problems were solved.
- (4) Letters will be judged strictly on the merits of the installation jobs, i.e.: the choice of properly-rated equipment for the particular service to be rendered, ingenuity in solving installation problems, also initiative and business ability displayed in consummating the deal. Literary style or manner of presentation will not be considered.
- (5) Photographs and diagrams, although not requisite to this contest, are desirable and shall be considered as a permissible influence upon the judges.
- (6) All letters, photographs or diagrams submitted become the property of *Radio-Craft*. None can be returned.
- (7) This contest is not open to the officials or employees of *Radio-Craft* Magazine nor to any officials or employees of the

companies submitting prizes for this contest.

- (8) The final closing date of this contest is midnight August 10th, 1939. All letters entered in this contest must be addressed to the PUBLIC ADDRESS CONTEST EDITOR, RADIO-CRAFT Magazine, 99 Hudson Street, New York, N. Y., and must bear the postal cancellation stamp not later than midnight, August 10th, 1939.
- (9) Section No. 2 of this contest opens May 11th and closes June 10th; Section No. 3, to be announced in the July issue, opens June 11th and closes July 10th; Section No. 4, to be announced in the August issue, opens July 11th and closes August 10th. Postmarked dates will be considered conclusive.
- (10) A board of judges will decide the winners and their decisions are final.
- (11) THE JUDGES FOR THIS MONTH'S CONTEST  
R. C. Reinhardt, of Atlas Sound Corp.  
Samuel Sherman, of Eastern Mike-Stand Company  
Wm. H. Manoff, of The Lifetime Corp.
- (12) A complete list of winners of Section No. 1 (May-issue contestants) will appear in the August, 1939 issue. Winners of Section No. 2 (June-issue contestants) will appear in the September, 1939 issue. Winners of Section No. 3 (July-issue contestants) will appear in the October, 1939 issue. Winners of Section No. 4 (August-issue contestants) will appear in the November, 1939 issue.

## THE LATEST RADIO EQUIPMENT

(Continued from page 735)

Bottom unit is a model 592 Set Tester. This "universal multimeter" has the following ranges: D.C., 8 ranges: 70/700 microamps.; 7/35/140/350 ma.; 1.4/14A. D.C. voltage, 25,000 ohms/volt, 7 ranges: 0-3.5/-7/35/140/350/700/1,400 V. D.C. voltage, 1,000 ohms/volt, 7 ranges: 0-3.5/7/35/140/-350/700/1,400 V. Resistance, 6 ranges: ¼-500/5,000/50,000 ohms/0.5-/5/50 megs. (all with self-contained battery). Ohmmeter provides for zero adjustment without removing prods from work. A.C. voltage, 7 ranges: 0-3.5/7/35/140/350/700/1,400 V. Output meter, 7 ranges; coupling condenser built-in. Decibels, 5 ranges: -10/+6; 0/+16; 10/+26 20/+36; 30/+46 db.



**TWIN-LIGHT MICROPHONE (1750)**  
(Astatic Microphone Laboratory, Inc.)  
TWIN lights with adjustable swivel on either side of the microphone, on this new Mike-Lite, throw a "rich halo of soft light" upon the performer. Assembly, on a 10-lb. stand, comes complete with a type T-3 crystal microphone (output level, -52 db.) and 25 ft. of cable.

**HIGH-FIDELITY ANTENNA COUPLERS (1751)**  
(Technical Appliance Corp.)  
MODERN radio receivers include an "extended" (to about 1,700 kc.) broadcast range which permits reception of the 4

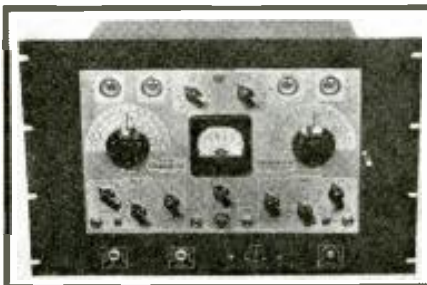

(Above) Rack-and-panel Chanalyst. (1752)  
(Left) Six-volt D.C., 110 V. A.C. phono and P.A. system. (1755)  
(Right) Latest pushbutton multi-range tester. (1754)

experimental high-fidelity broadcast stations in the United States. In order to afford best possible reception from its high-fidelity transmitter, station WQXR commissioned Amy, Aceves & King, through its licensee, TACO, to design the antenna (A) and receiver (B) couplers here illustrated.

These 2 units, placed at the end of existing transmission lines designed for ordinary broadcast reception, boost the voltage input at WQXR's frequency roughly 10 db. This stronger signal, plus the use of an anti-noise antenna system, results in static-free reception of the 4 high-fidelity stations. Where man-made static or weak reception are problems, in a "hi-fi" installation,



# JUST OUT!

A NEW GERNSBACK PUBLICATION  
The Constructive Photo Magazine



**ON ALL NEWSSTANDS**

FOR serious-minded amateur photographers, here's a photo magazine, FOTO-CRAFT, vastly different from any you've read. It tells you how and why to do things—it's a constructive publication which shows what can be done with the equipment you have, and how to make handy, photographic accessories. FOTO-CRAFT, with its broad editorial features, covers such important branches of photography as—New Scientific Researches; Developing; Printing; Enlarging; Dodging; Training; Photomicrography; Color Photography; Amateur Movies; How to Make It Items.

A Few of the Articles in the Current Issue:  
Still Life in Modern Mode—The Art of Projection Printing—Photo Rules Were Made to Be Broken—The Truth About Filters—The Photo Matrix—Photo Hints and Kinks—Photomicrography with Small Camera—New! Contra-Color Photograph—Develop Your Own 35 and 10" Photo Equipment; Pinhole Camera; Cameraless Photos with Invisible Rays; Stereoscopic Photos with a Hand Camera; Usink Your Camera as an Enlarger; Photo Pills in Soul—Photo Quiz—International Photo Digest—What's New—Questions and Answers—AND Several Prize Contests and A Color Filter. Absolutely Free.

**BIG OPPORTUNITY!** Get a FOTO-CRAFT Press Card today—with it you can get permission to take photos which might be difficult to obtain. PRESS CARDS are sent FREE to subscribers of FOTO-CRAFT. Enter your subscription for Seven Months for \$1.00—and get your PRESS CARD immediately.

**FOTO-CRAFT**

99-R HUOSON STREET NEW YORK, N. Y.

Radio Men find This Book Handy

**FORMULAS AND RECIPES**  
For the Practical Man

50¢ POSTPAID

Here is the Contents of the Book

1. Adhesives: Glues, Cements, Gums, Mucilages, Lubricants, 2. Cleansing: Stain Removers, Paint Removers, Bleaches, Cleaning Fluids, 3. Metal Craft: Coloring, Oxidizing, Plating, Repairing, Welding, Polishes, Alloys, Solders, Amalgams, 4. Paints: Colors, Stains, Varnishes, Enamels, Luminous Paint, Washable Paint; Paint-Removing, Waterproofing, Fireproofing, 5. Glass-Working: Cutting, Drilling, Boring, Reaming, Blowing, Etching, Engraving, Frosting, Silvering, etc., 6. Wood craft: Fillers, Fireproofing, Acid-proofing, Waterproofing Furniture Polishes, Finishes, etc. 7. Inks: Inks, Etchings, Eradicators, Ink Stain Removers, Special Inks, Colored, Indelible, Semibathetic, Invisible, Hectograph, 8. Photographic: Developers, Emulsions, Fixers, Sensitizing Toning, Printing Photographic Paper, Blueprint Paper, 9. Antidotes for Poisons, Remedies for Burns and Scalds, Disinfectants, First-Aid in Accidents, Emergency Remedies, Home Remedies, 10. Preparation, Manipulation, Handling, Mixing, Measuring, Weighing, Filtering, Straining Solutions; List of Technical Substances; Emulsifying; Use of Hydrometer; Use of Thermometer; Tables of Weights and Measures, Decimal Systems, Useful Tables.

**TECHNIFAX, Division RC-639**  
560 W. Washington Blvd., Chicago, Illinois

TECHNIFAX, Division RC-639  
560 W. Washington Blvd., Chicago, Illinois  
Gentlemen: Enclosed please find 50¢ check, money order, coin or unused U.S. stamps accepted for which send me POSTAGE PREPAID. One Copy of FORMULAS AND RECIPES For the Practical Man.

Name .....

Address .....

City ..... State .....



Latest high-gain dynamic microphone. (1753)

Servicemen may find it profitable to suggest the use of these 2 new units.

**2-INCH P.M. DYNAMIC SPEAKER (1749)**

(Oxford-Tartak Radio Corp.)

A PACKAGE of cigarettes looms large alongside the diminutive, permanent-magnet dynamic loudspeaker shown here. Overall size of the speaker is only 2½ ins. Alert Servicemen, experimenters, set builders and manufacturers will find that this new transducer (microphone-loudspeaker), a perfect instrument in every respect, makes possible many new devices in which space is at a premium.

**RACK-AND-PANEL CHANALYST (1752)**

(Service Instruments, Inc.)

HERE'S a rack-and-panel assembly of the Rider Chanalyst which Servicemen will find ideal for mounting with other bench equipment. Front-of-panel jacks speed the use of this instrument.

Servicing with a Chanalyst involves tracing the passage of the signal (incoming broadcast program, etc.) from antenna to loudspeaker; where the signal in a faulty receiver becomes distorted, takes on hum, or dies, is an instant indication of the location of the trouble and signifies the point at which final analysis, with meters, is to be made.

**HIGH-GAIN DYNAMIC MICROPHONE (1753)**

(American Microphone Co.)

AN output of about -48 db. at 1,000 cycles may be obtained with the new dynamic microphone shown here.

The type D6 is regularly supplied with an output impedance of 50 ohms and the D6T with a high impedance of 38,000 ohms (to grid). For long lines, low impedance is recommended. Output impedances of 200 and 500 ohms are obtainable on order. Ideal for general public address including stage sound-reinforcement, both permanent and portable installations. Both types readily meet the many varying acoustic problems encountered indoors; and outdoors as for playground and athletic field direction, police and amateur broadcasting, and recording. The face of the microphone affords a partial baffle effect which tends to enhance voice pick-up when speaking directly into the unit.

**PUSHBUTTON MULTI-RANGE TESTER (1754)**

(Approved Technical Apparatus Co.)

THE NEW Approved automatic model 1200E instrument is an A.C. and D.C. volt- (Continued on following page)

YOU CAN BECOME A MONEY-MAKING RADIO EXPERT WITH THE **New SPRAYBERRY** Personalized HOME TRAINING in RADIO and TELEVISION

You Learn Easily in Your Spare Hours ... By Doing Many Experiments with Up-To-Date Equipment

Here's a really fine, up-to-the minute Radio and Television Training that's specially designed to give you quick results.

TRAINING PREPARES YOU FOR GOOD RADIO JOBS ... AT EXCELLENT PAY. My training starts right at the beginning of Radio ... unfolds each subject in a simplified, logical, understandable style. You easily learn: Television, Electronics, Facsimile Radio, Radio set Repair, etc.

NO PREVIOUS EXPERIENCE NEEDED. No matter what your education has been, I can fit you for a good paying Radio job. Your success is my responsibility.

YOU GET PROFESSIONAL TEST EQUIPMENT PLUS EXPERIMENTAL OUTFITS

Includes 146 Radio Parts (to build complete Receiver), Tools, All-Wave, All Purpose Analyzer, and Experimental OUTFITS for conducting actual experiments with your own hands.

**I Supply**

146 RADIO PARTS  
RADIO TOOLS  
ALL PURPOSE ANALYZER

**SERVICEMEN:** I offer Advanced Training for those already in Radio. Get complete details in my FREE 32-page Book.

The Sprayberry Course is Sold Under a Money-back Agreement

**RUSH COUPON FOR BIG FREE BOOK**

**SPRAYBERRY ACADEMY OF RADIO**  
F. L. Sprayberry, Pres.  
320-F University Place, N. W.  
Washington, D. C.

Please send me FREE copy of "HOW TO MAKE MONEY IN RADIO"

Name ..... Age .....

Address .....

City ..... State .....

Tear off this coupon, mail in envelope or paste on penny postcard. Servicemen—check here ☐

**33 individual instruments**  
SUPER RANGE  
IN THIS ONE COMPACT  
**RCP SUPERTESTER**

AND THE PRICE NEWS IS JUST AS SENSATIONAL

only \$16.25

Think of it!

The equivalent of 33—yes, that figure is 33, test instruments in one! And all for a price so low that to call this SuperTester "your money's worth" is mild comparison. Model 411 is years ahead of any test instrument ever developed. You'll be dollars ahead from the day you own it! Voltage Ranges up to 5000 both A.C. and D.C.—Current ranges from microamps to 25 amperes both A.C. and D.C.—Resistance ranges from 0.1 to 4,000,000 ohms—Self contained batteries.

Model 411 complete \$16.25. Model 411B with provision for octal base ballast tube testing—\$17.95.

**HOW'S THIS FOR VALUE?**

New Dynoptimum Tube Tester, Model 307. Tests all latest type tubes, including octals. Tests under RMA voltages and load. High sensitivity neon short and leakage indication. Direct reading "Good-Bad" scale. Simple to operate. Fewer controls than any other approved circuit tester. Top quality, highly attractive. \$16.95.

Combination counter and portable model 307P—\$18.95.

SEE YOUR JOBBER OR WRITE FOR CATALOG.

**RADIO CITY Products Co.**  
88 PARK PLACE NEW YORK CITY

# PRICED FOR CLEARANCE!

**Rockbottom Prices on Overstocked New and Rebuilt Merchandise**

When prices are low we buy! They're low now—**LOWER THAN THEY EVER WILL BE**—hence this sale. Most of the merchandise is new—never used; some of it reconditioned. 100% satisfaction on each transaction or your money refunded. **ORDER FROM THIS PAGE.** Use the convenient coupon below. Be sure to include sufficient extra remittance for parcel post charges, else the order will be shipped express, charges collect. Any excess will be refunded. C.O.D. shipments require a 20% deposit. If full remittance accompanies order deduct 2% discount. Send money order—certified check—new U. S. stamps. No C.O.D. to foreign countries.

**ORDER TODAY      QUANTITIES LIMITED      QUICK SHIPMENTS ASSURED**

### WESTINGHOUSE WATTHOUR METER

Completely overhauled and ready for immediate service. Designed for regular 110-volt, 60 cycle 2-wire A.C. circuit. Servicemen use it in their shops to check current consumption of sets, soldering irons, etc. Keeps costs down. If dismantled, the parts alone would bring the price. The elaborate gear train could be used as a counter on machines of various kinds. Simple to install: 2 wires from the line and 2 wires to the load. Sturdily constructed in heavy metal case. Size: 8 1/2" high, 6 1/2" wide, 5" deep, overall. Shp. Wt. 14 lbs. ITEM NO. 33



**\$4.50**

### PORTABLE TELEGRAPH AND BUZZER FIELD SETS



Made for military use by Western Electric. A wonderful buy if only for the parts it contains. Never been used. Good for code practicing, signaling, communications, etc. Contains 2-tone, high-frequency buzzer with platinum contacts, telegraph key, telephone switches, earphone, condenser, transformers, chokes, etc. A \$50 value easily. Complete in wooden case with diagrams and instructions. Shp. Wt. 12 lbs.

ITEM NO. 16 **\$5.45**  
Your Price .....

## SERVICEMEN!—EARN MORE MONEY

### Electrifying Domestic Sewing Machines and Modernizing Floor Lamps

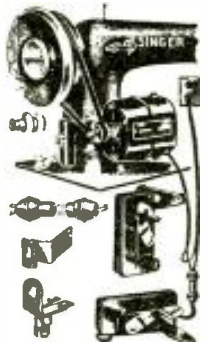

While you're repairing that radio suggest electrification of the old sewing machine. The cost is amazingly low. Every "foot-treadle" housewife is a likely prospect. Only one hole drilled to mount the entire assembly. Labor cost low, profit high.

#### COMPLETE EQUIPMENT SUPPLIED

Nothing else to buy. Kit includes motor, bracket to fit any machine (mention name), cord, pulley and rheostat for knee or foot control. Motor is 1/20 HP 110 volts AC or DC, 25 or 60 cycles, 5,000 RPM variable, double 1/4" shaft for either rotation, flat-sided case to permit use on drop-head machines. Size 5" x 3" x 2 1/4". Shp. Wt. 16 lbs.

ITEM NO. 37 **\$8.65**  
Your Price .....

#### I.E.S. CONVERTERS

Servicemen! There's no sales resistance to these lamp modernizers. You have the entire to homes and you have the right item. It's a perfect setup. Modernize an old floor lamp in 10 minutes right in front of your customer and one lamp job will lead to another. Remove the old assembly and install a new one. Attach to wood, metal, glass or porcelain stem. 10" I.E.S. diffuser with 3-way switch and cord and plug.

#### ITEM NO. 38

Converter without candle fixture **\$3.22**

Your Price .....

#### ITEM NO. 39

Converter with 3 candles **\$4.65**

Your Price .....



Shp. Wt. 8 lbs.

### WESTON MODEL 562 A.C.—D.C. AMMETER

Designed by Weston for the Eastman Kodak Co. Range, 0 to 6 Amperes. It is a precision-built magnetic-vane type ammeter which, with suitable shunts, can be made to measure heavier currents too. It is 2" in diameter and designed for panel mounting. Bakelite base and nickel-enamelled cover. Shp. Wt. 2 lbs.



ITEM NO. 35 **\$1.25**  
Your Price .....

### 1/20 HP 2-SPEED AC-DC MOTOR

Double-Shaft, 5000 and 230 RPM. Brand new back-gear motors. Never been used. Steel worm and fibre driven gears. The 230 RPM shaft is at right angles to main shaft and delivers power up, down, right or left by moving gear train. A suitable rheostat may be used for controlling the speed. Shaft is 3/16". For 110-volt A.C. or D.C. 25 or 60 cycles. Servicemen and others will find the double speeds useful for grinding, buffing, winding coils. Shp. wt. 12 lbs.



ITEM NO. 40 **\$5.25**  
Your Price .....

### 1/100 HP AC MOTOR

Excellent for experimenting, mechanical toys, dynamic window displays, etc. Develops 1750 RPM. Has 2-sided shaft with fan blade on one end for cooling the motor. Housed in sturdy case with attached mounting bracket. Shp. Wt. 5 lbs.



ITEM NO. 41 **\$1.49**  
Your Price .....

### FAMOUS VACUUM CLEANERS

Rebuilt Like New  
Guaranteed for 6 Months

We give you new brushes, bags, handles, belts and other parts. The chassis is replated. All moving parts overhauled. Money back if not satisfied.



ELECTROLUX NO. 11—Radical design, cylinder type motor. Complete with all attachments. Foot control switch. Has 101 uses: cleaning upholstery, walls, draperies, curtains, mattresses, etc. Shp. Wt. 18 lbs. List Price, \$69.75.

ITEM NO. 30 **\$16.48**  
Your Price .....

HOOVER NO. 108—Motor driven brush. Foot control switch. Black enameled steel motor housing. 12-inch nozzle. Shp. Wt. 24 lbs. List price, \$63.50.

ITEM NO. 28 **\$13.95**  
Your Price .....

### MOTOR-SPEED REDUCER

Reduces the speed of electric motors 12 1/2 times. The gears are totally enclosed in a steel case. Shaft, 1/2", sleeve bearings 2 3/4", shaft extension 3 1/4", base to shaft centers 7". High speed shaft on top. Mounting bolts 3 1/16" x 2 3/4". Shp. Wt. 8 lbs.



ITEM NO. 42 **\$4.72**  
Your Price .....

**WE HAVE NO CATALOG. ORDER FROM THIS PAGE.**

## HUDSON SPECIALTIES - 40-RC West B'way - N.Y.C.

**IT'S EASY TO ORDER—CLIP COUPON—MAIL NOW**

HUDSON SPECIALTIES CO., 40-RC West Broadway, New York, N. Y. RC-639

I have circled below the numbers of the items I'm ordering. My full remittance of \$..... (include shipping charges) is enclosed.

OR my deposit of \$..... is enclosed (20% required), ship order C.O.D. for balance. (New U.S. stamps, check or money order accepted.)

Circle Item No. wanted: 16 28 30 33 35 37 38 39 40 41 42

Name ..... Address .....

City ..... State .....

Send remittance by check, stamps or money order; register letter if you send cash or stamps.

## THE LATEST RADIO EQUIPMENT

(Continued from preceding page)

ohm-ma. tester. Its automatic pushbuttons cut testing time considerably. The instrument uses a 0 to 1 ma. 3-in. square D'Arsonval meter with 1,000 ohms/volt sensitivity. Among its many ranges are: D.C. volts, 0, 2.5/10/50/250/500/2,500; A.C. volts, 0/15/150/1,500; D.C. ma., 0/1/10/100/1,000 (1 amp.); ohms, 0/2,500/25,000/250,000; output ranges, 0/15/150/1,500; decibel ranges -10/+19, -10/+38, -10/+53; D.C. amperes, 0/10/25; power, 0.006000- to 600 watts; inductance, 1/700 henries; D.C. measurements of leakage in electrolytic condensers; qualitative paper condenser tests.

### 6-V. D.C., 110-V. A.C. ELECTRIC PHONOGRAPH AND P.A. SYSTEM (1755)

(Amplitone Products Company)

**NEWEST** in electric phonographs and P.A. units is the Amplitone streamlined model AM-66, designed for the so-called "universal" operation in performing on optional power supplies of 6 V. D.C. or 110 V. A.C. Power output is 15 to 20 W. on either voltage. Other features are low battery drain, instant changeover to either operating voltage by means of a switch and, built-in phono and pickup assembly. As the illustration shows, the assembly is extremely compact. Costing less than \$50, this system includes electronic phono-mike mixing.

### List of Prizes

(Continued from page 722)

2 ELEVENTH PRIZES—Auto-Top Carrier for Mobile Sound Installations, platform size, 30 x 54 ins., type PA26, \$22.50

Offered by Vac-O-Grip Company

Microphone, type D7T, \$22.00

Offered by Allied Radio Corp.

2 TWELFTH PRIZES—Auto-Top Carrier for Mobile Sound Installations, platform size, 30 x 36 ins., type PA22, \$16.00

Offered by Vac-O-Grip Company

P.M. 12-in. Dynamic Speaker, type FB 12-M, \$15.50

Offered by Cineaadgraph Corp.

THIRTEENTH PRIZE—"Chandelier" Baffle with Speaker Unit, type S-360, \$12.50

Offered by Atlas Sound Corp.

2 FOURTEENTH PRIZES—Floor-Type Chrome Microphone Stand, model EF-17, \$12.50

Offered by Eastern Mike-Stand Company

Floor-Type Chrome Microphone Stand, model EF-17, \$12.50

Offered by Eastern Mike-Stand Company

2 FIFTEENTH PRIZES—Desk-Type Microphone Stand, type ED-127, \$3.75

Offered by Eastern Mike-Stand Company

Desk-Type Microphone Stand, type ED-127, \$3.75

Offered by Eastern Mike-Stand Company

**THIS MONTH—A TOTAL OF 20 VALUABLE AWARDS OF PUBLIC ADDRESS EQUIPMENT! Count 'em!**

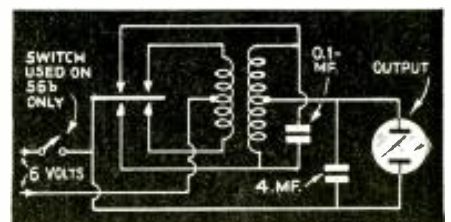

THE POWER PACK FOR DRY SHAVERS, shown as The Radiart Corp.'s item No. 1683 in Oct., 1938, *Radio-Craft*, is diagrammed above. Transformer has split primary, each half rated at 2.8 A. at 6 V. or 0.5-A. at 32 V. Secondary, also split, is rated at 100 ma. at 110 W. (each half).

Please Say That You Saw It in RADIO-CRAFT

# FREE - REAL ELECTROPLATING OUTFIT



Now You Can **ELECTROPLATE** Easily with a **BRUSH**

SOMETHING new for radio men—something which gives you the opportunity to make additional profits—or to improve your type of service. Here's an **ELECTROPLATING KIT** amazingly simple to operate—you just Electroplate with a Brush!

### NOT A TOY!

You can electroplate for profit, hundreds of things in the household—ashtrays, fixtures, water faucets, worn brackets, door knobs, musical instruments, jewelry and silverware and other articles. It's an indispensable piece of equipment to you for plating articles in hotels, apartments, office buildings, medical and dental offices, factories, schools, laboratories, etc. Exactly the same outfit (but larger) is used professionally by electricians, radio service men, automobile repair shops, etc. Requires one single dry cell 1½-volt battery to operate.

And for radio work, you can electroplate tarnished receiver parts, escutcheons, contacts, worn radio parts and accessories, and display chassis. Put this **REAL ELECTROPLATING KIT** to use immediately—make it the most useful article in your shop or laboratory. And, you can get it absolutely **FREE** (except for slight mailing cost).

Send your subscription today to **RADIO-CRAFT** for One Year (12 issues) and receive absolutely **FREE** this **REAL ELECTROPLATING KIT**. New subscribers are accepted or you may extend your present subscription another twelve months under this offer. Mail your remittance of \$2.50 (plus 10c for shipping charge on kit) to the publishers of **RADIO-CRAFT** (Canada and foreign \$2.85). You will promptly receive your **FREE, REAL ELECTROPLATING OUTFIT** by return mail. Use the coupon below to order your subscription.

### RADIO-CRAFT

99 Hudson Street New York, N. Y.

RADIO-CRAFT RC-639

99 Hudson Street, New York, N. Y.

Gentlemen: Enclosed you will find my remittance of \$2.50 for which enter my subscription to **RADIO-CRAFT** for One Year (12 issues). Send me promptly my **FREE, REAL ELECTROPLATING OUTFIT** (Canada and foreign \$2.85). In U. S. add only 10c additional to cover shipping charges on kit.

New Subscriber  Extend Present Subscription

Name .....

Address .....

City ..... State .....

(Send remittance by check, money order or unused U. S. Postage stamps. Register letter if you send cash or stamps.)

## "FOR DISPLAY PURPOSES ONLY!" . . . .

(Continued from page 713)

as these drums are at right-angles to each other, the cord must pass over pulleys.

The aforementioned Catalan base has holes drilled through the base to serve as "bleed holes". These holes return the water to the pool. Running through the side are three 8-32 screws which hold the globe. The first base (upper) is set on top of another similar base which serves as a guide. These are tongued and grooved so that no water can slip through the joints. Not that the joints are tight, but the tongue of the lower disc rises above the water level. The lower disc is cemented to the base and forms the pool's inner wall.

When the globe is turned, the set (under base) is tuned! The volume control passes through the base and is outside of the rim of the pool. To indicate the station to which the set-chassis is tuned, a pointer fastened to the Trylon extends far enough to reach graduations on the Perisphere.

Only one last point needs to be covered. The set is fastened under the base with small metal brackets. The speaker is attached in a similar fashion, the cone pointing downward toward the table. To get an even distribution of sound a small wooden turned disc in cone shape is mounted under the mouth of the speaker. Thus, the sound waves are deflected outward and seem to emanate equally in all directions from the center of the base. The base may be raised from the table, or sound-outlet holes may be drilled in the chromium-plated metal band.

The lamp in the "perisphere" has a small, jeweled pin affixed to the top with sealing wax. On this pin is mounted a heat-operated cylinder which gives the globe a beautiful rolling cloud effect with revolving opalescent blending colors. This must be seen to be appreciated; as an attention-getter it's hard to beat.

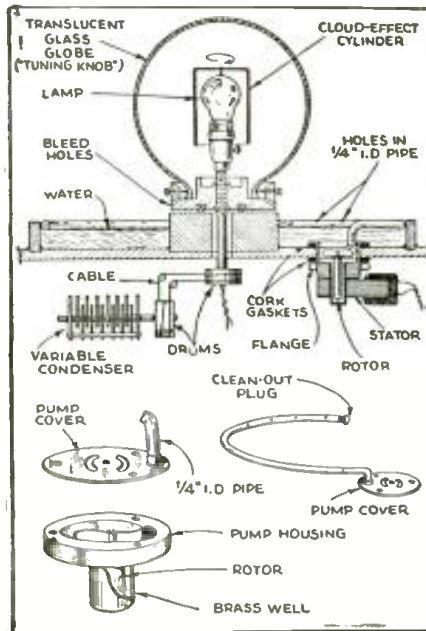

Complete details for making the fountain pump and for connecting the Perisphere "tuning knob" to the variable condenser located underneath the chassis.

### CREDITS

The Theme unit itself, that is the *Perisphere, Trylon, Helicline* (inclined ramp), etc., mounted on an imitation onyx Catalan

(Continued on following page)

Please Say That You Saw It in **RADIO-CRAFT**

## METALEX HORNS



Model MX6AN

### The Popular Horn of the San Francisco World's Fair

- Spun from steel
- Lasts indefinitely
- Coated with "Ex"
- No objectionable resonances

Their worth is rapidly becoming recognized in the engineering field.

Price complete with Nokoil Speaker. List **\$16.50**

Write for circulars and complete information.

Those Who **KNOW** Demand **Wright-DeCoster**

### WRIGHT-DECOSTER, Inc.

2251 University Ave., St. Paul, Minn.  
Export Dept.: M. Simons & Son Co., New York  
Cable Address: "Simontrice"

Canadian Representatives:  
Wm. F. Kelly Co., 1207 Bay St., Toronto, Ontario  
Taylor & Pearson, Ltd., Edmonton, Alberta

## THIS BOOK FREE!

**COVER TO COVER**  
*it's a money saver!*  
**AND IT COVERS everything in radio!**

▼ Send for your **FREE** copy today! Ham, serv- ▼  
▼ iceman or dealer—you'll find this great 1939 ▼  
▼ catalog made to order for you. It's brand new, ▼  
▼ a marvel of completeness and right up to the ▼  
▼ minute! Everything in radio, including the ▼  
▼ talked about Built-It Yourself Kits, a big section ▼  
▼ on streamlined P.A. systems, test equip- ▼  
▼ ment . . . prices that save you real money! No ▼  
▼ mere scattering of bargains in this book. Cover ▼  
▼ to cover, it's one long parade of money-saving ▼  
▼ values. Put it to the test! Get a **FREE** copy. ▼  
▼ Simply tear off coupon and mail today! ▼

**LAFAYETTE RADIO CORP.**  
**AND WHOLESALE RADIO SERVICE** CO. INC.

NEW YORK, N. Y. • CHICAGO, ILL. • ATLANTA, GA.  
100 SIXTH AVENUE • 311 W. JACKSON BLDG. • 265 PRITCHETT ST.  
BOSTON, MASS. • BRONX, N. Y. • NEWARK, N. J. • JAMAICA, L. I.

Rush New **FREE** Radio Catalog No. 76.

NAME..... PLEASE PRINT

ADDRESS.....

CITY.....STATE.....

**LAFAYETTE RADIO CORP.**  
Dept. 3F9—100 Sixth Ave., New York, N. Y.

PASTE COUPON ON PENNY POSTCARD

# QUALITY—VALUE—GUARANTEE!

## WESTINGHOUSE POWER GENERATOR

Manufactured for U. S. Signal Corps

**A. C. ELECTRICAL POWER**  
 from a Windmill, from available Waterpower, from your Automobile, from your Motorcycle, from your Bicycle, Footpedals or Handcrank (for transportable Radio Transmitters, Strong Floodlights, Advertising Signs); operate two generators in series to get 200 V. AC; obtain two phase and three phase AC, etc., etc.

**There Are Over 25 Applications**  
 Some of which are:

A.C. Dynamo lighting from eight to ten 20 Watt 110 Volt lamps. Short Wave transmitter supplying 110 Volt AC for operating "Ham" transmitter. Motor generator, Public Address Systems, Electric Sirens on motor boats, yachts, etc. Camp Lighting. Short Wave artificial lighting apparatus. Television. Pelton Waterwheel for lighting or other purposes. Airplane: for lighting strong search lights or electric signs. Laboratory work, etc., etc.  $\frac{1}{2}$  lb.  $\frac{1}{2}$  needed to run generator.

Generator, as described, including BLUE PRINT 22 x 28 in. and Four-Page 8 1/2 x 12 in. INSTRUCTION SHEETS ..... **\$7.90**  
 Send \$2.00 deposit balance C.O.D. Shipping weight 18 lbs.

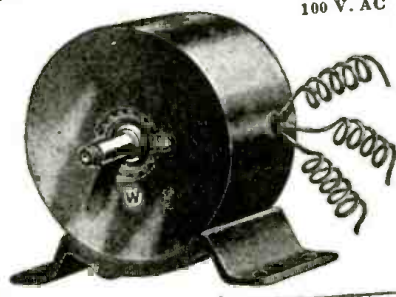

200 Watt.  
100 V. AC

## WESTINGHOUSE UNIVERSAL MOTOR



**\$2.55**

110 Volts  
AC and DC  
Shipping  
Weight  
3 lbs.

Specifications: 1/30 H.P., operates on either A.C. or D.C., 110 volts, 5000 R.P.M., Rheostat can be used to vary speed. Height 3 1/4", Length 3 3/4", Width 1 1/4", Shaft 1/4" one inch long. Can be used to drive Sewing Machines, Models, Buffing Lathes, Polishing Head, Drills, Grindstones, etc., etc.

MOTOR only ..... **\$2.55**  
 MOTOR with Arbor and 1/4" Chuck ..... **\$3.55**  
 Add 25c for special packing and mailing anywhere in U. S. A.

## G. E. PHONOGRAPH MOTOR

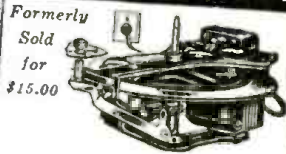

Formerly  
Sold  
for  
\$15.00

**\$ ONLY 4.95**

Variable speed induction type self-starting, 110 volt, 25 to 60 cycle, A.C. with speed control, plug and cord. Speed range from 5 to 200 R.P.M. Can be installed in place of old-fashioned, hand-wind and a hundred other uses. These General Electric Motors have never been used and come four packed in original carton. G. E. Electric Phonograph motor as described (with-out turntable) ..... **\$4.95**

Shipping Weight—12 lbs.

**ALL OUR MERCHANDISE IS UNUSED AND SOLD ON A MONEY-BACK GUARANTEE**

## MICROPHONE AND RECEIVER

This Microphone and telephone headset outfit was built especially for the U. S. Navy Aviation Corps, the outfit to Government specifications constructed by the Holtzer-Cabot Electric Company.

The outfit consists of a low-impedance carbon microphone (transmitter), securely fastened to a metal breastplate, and a set of heavy-duty, low-impedance earphones. A specially constructed switch on the back of the breastplate controls the microphone circuit. The earphones are U.S.N. "Ush" type, attached to adjustable headband. Twenty-eight feet of very heavy weather and waterproof conductor cable is furnished. Current of not more than 10 volts should be used. A storage battery is the most satisfactory current supply.

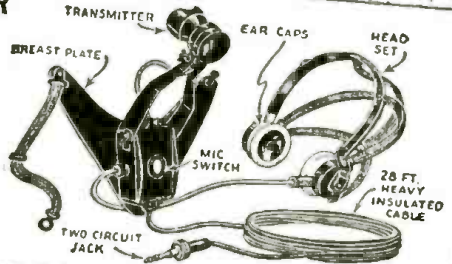

U. S. Navy Airplane-type Microphone and Receiver as described ..... **\$4.96**  
 Shipping Weight—9 lbs.

## WELLWORTH TRADING CO.

Dept. RC-639  
560 W. WASHINGTON BLVD., CHICAGO, ILL.

\* ORDER DIRECTLY FROM THIS ADVERTISEMENT \*  
 WE SHIP 24 HOURS AFTER RECEIPT OF YOUR ORDER, BY EXPRESS COLLECT OR PARCEL POST IF YOU INCLUDE SUFFICIENT POSTAGE.

base and encircled with a chromium band, is made by an organization which was licensed by the World's Fair Corp. to manufacture this strikingly novel lamp (in addition to many other novel and useful articles).

The Theme is available in 3 sizes: on an 8-inch base, a 10-inch base, and a 16-inch base. The latter was used for the production of the radio set combination described in this article, and was especially made for Radio-Craft by the engineering staff of the American Pearl and Bead Company, co-operating with the F.R.S. Novelty Co.

Mr. J. Crawford Rivers, president of the latter company, reports that by the time this issue of "R.-C." appears on newsstands, his company probably will be manufacturing the Theme with the fountain, and also with the radio combination; however, he will be glad to supply the Themes at manufacturing cost (which is very reasonable) to any experimenter who would like to construct a unit similar to that described in this article. In the same spirit of cooperation, the owner of the patent for the fountain will extend to experimenters the privilege of employing this fully-protected principle for the builder's own personal use only. However, the fountain unit cannot be manufactured for resale without a special license.

(Data on the parts for the fountain are given in the second section of the following "LIST OF PARTS," headed "Theme Fountain.")

### LIST OF PARTS—Theme Set

#### CONDENSERS

- One Cornell-Dubilier electrolytic, type BR2015, 150 V., 20 mf.;
- One Cornell-Dubilier dual electrolytic, type JR288, 8 mf.;
- Two Cornell-Dubilier paper, 0.05-mf., 400 V.;
- Two Cornell-Dubilier paper, 0.02-mf., 400 V.;
- Four Cornell-Dubilier paper, 0.01-mf., 400 V.;
- Two Cornell-Dubilier paper, 0.1-mf., 400 V.;
- One Cornell-Dubilier paper, 0.25-mf., 400 V.;
- One Cornell-Dubilier mica midget, 100 mmf.;
- One Cornell-Dubilier mica midget, 250 mmf.;
- One Cornell-Dubilier mica midget, 0.001-mf.;

#### RESISTORS

- One I.R.C. insulated, 0.1-meg., 1/2-W.;
- One I.R.C. insulated, 0.2-meg., 1/2-W.;
- One I.R.C. insulated, 0.5-meg., 1/2-W.;
- One I.R.C. insulated, 3 megs., 1/2-W.;
- One I.R.C. insulated, 2 megs., 1/2-W.;
- One I.R.C. insulated, 50,000 ohms, 1/2-W.;
- One I.R.C. insulated, 300 ohms, 1/2-W.;
- Two I.R.C. insulated, 20,000 ohms, 1/2-W.;
- One I.R.C. insulated, 200 ohms, 1/2-W.;
- One I.R.C. volume control (A.F. taper) with switch, 0.5-meg.;
- One Meissner input I.F. transformer, No. 16-5740, 465 kc.;
- One Meissner output I.F. transformer, No. 16-5742, 465 kc.;
- One Meissner adjustable antenna coil, No. 14-7413;
- One Meissner oscillator coil, No. 14-7560;
- One Meissner dual variable condenser, No. 21-5214, 365 mf.;
- One Meissner padding condenser, No. 22-7005, 175-500 mmf.;
- One Sylvania type 7A8 tube;
- One Sylvania type 7B7 tube;
- One Sylvania type 7C6 tube;
- One Sylvania type 35A5 tube;
- One Sylvania type 35Z3 tube;
- Five Sylvania loctal sockets;
- One Best Manufacturing Co. 5 1/4-in. P.M. dynamic speaker with transformer to match 2,500 ohms;
- One Ohmrite line cord resistor, No. C-180, 180 ohms;

300 WAYS TO MAKE MONEY



MAIL ORDER PLANS  
TESTED MONEY MAKERS  
BUSINESS SECRETS  
SUCCESS SCHEMES

25 CENTS

## EXTRA Money For You

A Marvel Book 40,000 Words in Text!

In "CASH IN" you get ALL the real money-makers—dozens of profitable tested mail order plans, confidential business secrets, dozens of practical tested formulas, successful tested schemes—actual experiences of men who have started on a shoestring—with less than \$10 capital. Money-Back Guarantee.

"CASH IN" contains only tested ideas covering every type of full—or spare-time enterprise—it's a "master-piece" in business ventures.

25 CENTS per copy. Sent POSTPAID anywhere upon receipt of 25 cents U. S. stamps or coin.

NATIONAL PLANS INSTITUTE, 246-R Fifth Ave., New York, N. Y.

Please Say That You Saw It in RADIO-CRAFT



**OPPORTUNITY AD-LETS**

Advertisements in this section cost five cents a word for each insertion. Name, address and initials must be included at the above rate. Cash should accompany all classified advertisements unless placed by an accredited advertising agency. No advertisement for less than ten words accepted. Ten percent discount for six issues, twenty percent for twelve issues. Objectionable or misleading advertisements not accepted. Advertisements for July, 1939, issue must reach us not later than May 6th.

Radio-Craft • 99 Hudson St. • New York, N. Y.

**AGENTS WANTED**

**300% PROFIT SELLING GOLD LEAF LETTERS FOR** store windows; Free samples. Metallic Company, 451 North Clark, Chicago.

**GET UNSEEN, UNBELIEVABLE, THRILLING SEN-**sational Eastern novelties. Samples 50c. Motiwalla Bros., Third Rhoiwada, 38V, Bombay, 2, India.

**BOOKS AND MAGAZINES**

**WE HAVE A FEW HUNDRED RADIO ENCYCLO-**pedias, by S. Gernsback, second edition, originally sold at \$3.98. Book has 372 pages, weight 3 lbs., size 9 x 12 inches. Red morocco—keratol flexible bindings. Send \$2.49 in stamps, cash or money order and book will be forwarded express collect. Technifax, 558 W. Washington Blvd., Chicago, Illinois.

**BUSINESS OPPORTUNITY**

**RECEIVE STACKS MAIL OPPORTUNITIES GALORE,** magazines, samples. Your name printed 5,000 directories 10c—15,000, 25c. Wilsons, 2408 1/2 Ave. Everett, Washington.

**CAMERAS & SUPPLIES**

**AMBERTINT 16MM. CAMERA FILM, \$1.85 FOR 100** feet, including machine processing. Daylight loading Weston Film. Nonhalation. Two rolls \$3.50. Order now. Hollywood Studios, Southgate, Calif.

**GENERA FILM—ALL MOVIE CAMERAS, 100 FEET** 8 mm, \$1.00; double, \$1.75; 16mm, \$1.35. Sample for stamp. Processing Powders, Outfits. Fromaders, Davenport, Iowa.

**BULK FILM: 100 FT. 8MM, \$90; DOUBLE, \$1.60;** 16 mm., \$1.20. Titles of pictures. Chemicals, outfits. Big catalog for stamp. Hollywoodland Studios, South Gate, Calif.

**COINS AND STAMPS**

**STAMP COLLECTORS—INTRODUCTORY OFFERING—**103 stamps including scarce BI-colored Diamond and Triangular shaped Commemoratives—10c. Approvals. Friendly Philatelists, Box No. 4428R, Philadelphia, Penna.

**53 U.S.A. FARLEY'S, TIPEX, COMMEMORATIVES,** rev. postage, coronations, jubilies, air mails and lists 25c. Box 211, Malden, Mass.

**EDUCATIONAL COURSES**

**USED CORRESPONDENCE COURSES AND TECHNICAL** books, bought, sold, rented, exchanged. Catalog free. Vernon's Exchange, Henagar, Alabama.

**USED CORRESPONDENCE COURSES AND RADIO** service manuals bought, sold, exchanged. Send for big bargain list at once. Cash for used courses, service manuals, etc. Educational Exchange Company, Box 87, Ft. Payne, Ala.

**FOR INVENTORS**

**CASH FOR UNPATENTED IDEAS, STAMP APPRE-**ciated. Mr. Ball, 9431-J Pleasant, Chicago.

**MISCELLANEOUS**

**MEXICAN DIVORCES: NO PUBLICITY. AMERICAN** attorney. Box 1736, El Paso, Texas.

**MONUMENTS & TOMBSTONES**

**GENUINE MARBLE, GRANITE, FREIGHT PAID,** Catalog free, \$11 up. United States Marble & Granite Co., A-27, Oneco, Fla.

**OFFICE SUPPLIES**

**SEND COPY AND \$1.00 FOR 125 8 1/2 x 11 BOND** letterheads and 125 envelopes, both beautifully printed. Benneville, 907 West Roosevelt, Philadelphia.

**RADIO**

**SPEAKER FIELD, MAGNETIC, RELAY AND SOLENOID** coils made to specifications. Single or large lot orders. Also rewinding. Nothelfer Winding Laboratories, P. O. Box 455, Trenton, New Jersey.

**WE BUY AND SELL USED RADIO TESTING EQUIP-**ment. Time payments if desired. Harold Davis, Inc., Jackson, Miss.

**ANY RADIO CIRCUIT DIAGRAM 25c. ORDER MENTIONING** manufacturer's name, model. Catalog free. Supreme Publications, 3727 West 13th, Chicago.

**SERVICEMEN: RADIO CARTOONS ENLIVEN AD-**vertising, boost business. Cut catalogue 10c. Radiolabs, Winnipeg, Canada.

**SUPREME 585 DIAGNOMETER, PERFECT, LIKE** new, \$70. Schutz, 1152 East 224th Street, New York City.

**ALUMINUM—IN ALL COMMERCIAL FORMS,** sheets, bars, rods, radio panels, angles, moulding, foil. Immediate delivery. Empire Aluminum Company, Station D, Box 97, New York City.

**SERVICEMEN!! LOCATE INTERMITTENTS QUICKLY** with new tool, \$3.50 with money-back guarantee. Anderson, 910 French Street, Wilmington, Delaware.

**TOUCH-D-MATIC ELECTRIC BUTTON TUNING UNITS** to modernize any car radio. NOT A KIT. Brand new complete units in factory sealed cartons. Includes electric 6 volt relay, 15 trimmers, each 10 mmfd. to 450 mmfd., 4 foot shielded cable, six button bakelite control head, etc. Only \$1.95 plus postage, shipping weight 5 lbs. Parke Radio, 1826 N. Springfield, Chicago, Ill.

**110 VOLT, 60 CYCLE GENERATORS FOR RURAL** districts. \$5.00. Guaranteed. J. Orysen, Kennan, Wisconsin.

**SONG POEM WRITERS**

**SONGWRITERS! MELODY FOR WORDS \$1.00,** Little, 215 Mason Theatre, Los Angeles, California.

**MISCELLANEOUS**

One sheet aluminum, 7 x 10 x 1/16-in. thick;  
One piece aluminum, 3 1/2 x 3 x 1/16-in. thick.

**LIST OF PARTS—Theme Fountain**

One American Pearl and Bead Co. theme unit and base complete, ready for use in this construction;  
One Barber-Colman 20-W. A.C. synchronous motor, stripped and reamed;  
Two drum dials, 1/4-in. x 1 1/2 ins. dia. (one with 1/4-in. bore and one with 3/8-in. bore);

**MISCELLANEOUS**

Copper tube, pipe fittings, brass bar, solder, drills, socket, wire, etc.

**THE BEGINNERS' SIMPLE VOLT-MILLIAMMETER**

(Continued from page 733)

position can do no damage because the voltmeter circuit can only be completed through a plug in the proper jacks.

Resistor R1 is added to the internal meter resistance for two purposes. One is to increase the value of the shunting range resistors to a practical and more easily obtained value. The other is to reduce the effect of variable contact resistance in the jack switches.

In Fig. 1 the resistors are further designated as to values in the paragraph which follows. From top to bottom they are identified as follows: Left, R2, R3, R4, R5; right, R6, R7, R8, R9, R10.

Resistors R2 to R5, incl., shown for the voltmeter ranges may be purchased through any radio parts supply house and will give greatest meter accuracy if so obtained. Values: R2, 10,000 ohms; R3, 90,000 ohms; R4, 0.4-meg.; R5, 0.5-meg. Resistor R1 is simply a 1,000-ohm, 1/2-W. compensating resistor and for this reason need not be accurate as to value.

Milliammeter shunt resistors R6 to R10, incl., have calculated values as follows: R6, 2 ohms, 1 W.; R7, 8.1 ohms, 1/2-W.; R8, 10.3 ohms, 1/4-W.; R9, 90.7 ohms, 1/4-W.; R10, 138.9 ohms, 1/4-W.; R10, 138.9 ohms, 1/4-W. If resistor R1 is omitted the above shunts will have much smaller values; but then, it will be possible to obtain them from the meter manufacturer through the regular distributor. As previously mentioned, R1 is desirable, thus making it almost necessary that these shunts be handmade by the "cut and try" method. The quickest method for doing this is to connect a meter of known accuracy in series with the meter being calibrated and a potentiometer, across a low-voltage D.C. supply. Then proceed to adjust the value of shunt resistance to obtain like readings on both meters.

This same idea may be carried a step farther by adding A.C. voltage ranges to the above meter circuit. This would require the addition of a rectifier and additional switching circuits.

(You may perhaps be puzzled by the fact that the circuit diagram indicates 5 milliamperage ranges and 4 voltage ranges [a total of 9 ranges] whereas the illustration of the completed instrument in Fig. A shows provisions for only 7 ranges. This is explained by the fact that the circuit was changed subsequent to the completion of the original model. Figure 2 shows a sketch of a front panel, suggesting the new positions of the range jacks.—Editor)

(Continued on following page)

**GET THIS WORLDS! GREATEST RADIO CATALOG FREE! 164 PAGES of Super Values! Everything in Radio AT LOWEST PRICES!**

The New 1939 Radolek Radio Profit Guide is the world's finest, most complete Catalog of Radio Parts and Equipment. Completely revised, right up to the minute, bringing you "Everything in Radio" AT LOWEST PRICES! Packed with money-saving radio-buying information every page brings you EXTRA PROFITS. Contains over 12,000 items—the most comprehensive exact duplicate replacement parts listings of Volume Controls, Condensers, Transformers, Vibrators ever compiled. A complete new selection of Radio Receivers and Public Address Equipment, Tubes, Auto Radios and Test Equipment. New profits for you in Electrical Appliances, Clocks, Power Tools, Electric Shavers, etc. Radolek offers you one complete speedy source for all your radio needs—a complete stock ready for prompt shipment to you. This Book is your handy index to Radolek's huge storehouse of Radio Super-Values. You need it—it's FREE.

**MAIL THIS COUPON**

**The RADOLEK Co.**

601 W. Randolph, Chicago, Dept. C-30

Send the 1939 Radolek Radio Profit Guide Free.

Name .....

Address .....

Serviceman?  Dealer?  Experimenter?

Please Say That You Saw It in RADIO-CRAFT

# EXTRA PROTECTION!

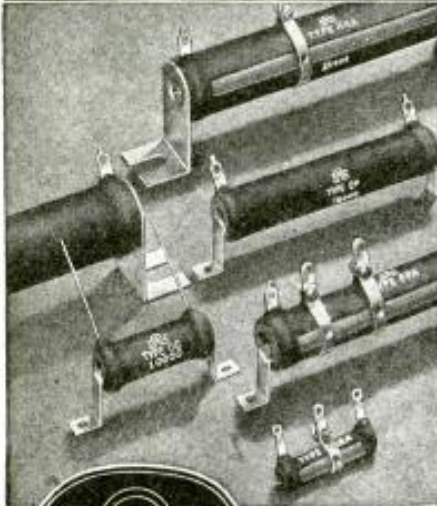

## POWER WIRE WOUND RESISTORS (Cement Coated)

That special cement coating on IRC Power Wire Wound Resistors is just as rough and tough as it looks. It is the most durable coating yet developed. It is practically impervious to moisture and heat. It doesn't peel, chip or crack. It offers EXTRA PROTECTION against the most common causes of resistor failure. It gives you true airplane — submarine resistance dependability — at not one cent of extra cost. Its amazing superiority can be demonstrated by any test you care to name. Ask your jobber. Insist on IRC Power Wire Wounds — the only resistors having this exclusive feature.

### A 10-WATT SERVICE HINT

Hundreds of servicemen and amateurs save time and money by using these little 10-watt IRC Power Wire Wounds universally for all low wattage resistor requirements. The 10-watt adjustable (Type ABA) is especially handy. Any desired range up to the maximum of the resistor can be tapped off by moving the adjustable band. A few popular ranges equip you for literally hundreds of jobs.



## INTERNATIONAL RESISTANCE CO.

401 N. Broad Street, Philadelphia, Pa.

### List of Parts

- One Weston D.C. meter, 0-1 ma. (50 ohms);
- One pushbutton switch;
- One Littelfuse 10 ma. fuse (in clip holder);
- One resistor, 1,000 ohms;
- One Shallcross Akra-ohm resistor, 10,000 ohms;
- One Shallcross Akra-ohm resistor, 90,000 ohms;
- One Shallcross Akra-ohm resistor, 0.4-meg.;
- One Shallcross Akra-ohm resistor, 0.5-meg.;
- One set ma. shunts (These shunts may be home-made; or they may be obtained from the meter manufacturer or any radio mail-order house.);
- Four Yaxley phone jacks with a single-circuit-opening switch attached;
- Five Yaxley phone jacks with a 2-circuit-opening switch attached (The above switches must be insulated from the jack circuits.);
- Three binding posts;
- One home-made box, cut to any desired dimensions.

## COMBINED A.C.-D.C. — BATTERY PORTABLE

(Continued from page 738)

antenna. Replacing the cover materially alters the inductance of the loop and thus throws the R.F. alignment out. But the iron core of this oscillator coil inductance is adjustable through a hole in the bottom of the cabinet and thus permits a final touching up of the alignment under normal operating conditions. This arrangement also provides for alignment to compensate for the use of an external antenna.

Under all ordinary circumstances, the use of an external antenna is unnecessary. Walking around one of the lower floors in a steel frame office building in downtown New York, for instance, it was possible to tune-in stations in Philadelphia and Bridgeport at noon-time and, of course, all local stations were heard with more than adequate volume. And it is of more than passing interest that turning the receiver (and therefore the loop) at right-angles to either of these out-of-town stations dropped them out of the picture, a stunt of which advantage can be taken in noisy locations to eliminate noise where its source lies in a direction other than that of the desired station.

The primary purpose of the antenna and ground connections is to provide for satisfactory reception when 'way out in the country where the desired stations are far distant. Thus this little receiver is not only truly universal so far as power and portability are concerned, but is also capable of real DX reception when occasion requires.

*This article has been prepared from data supplied by courtesy of Lafayette Radio Corp.*

### PHOTO CORRECTION

In the article, "Sound-on-Wire Tape!," in May 1939 *Radio-Craft*, the photo at lower left, pg. 654, has 2 arrows pointing at the erasing head. The recording and playback head is the unit below, and shown split open.

### FREE LIST

Numerous articles on electronic music have appeared in past issues of *Radio-Craft*. Upon receipt of a self-addressed, stamped envelope, we shall be glad to send you the complete list.

## Index to advertisers

|   |                    |
|---|--------------------|
| <b>A</b>                                  |                    |
| Alden Products Company.....               | 758                |
| Allied Radio Corporation.....             | 749                |
| American Microphone Company.....          | 754                |
| Amperite Corporation.....                 | 746                |
| Amplifier Company of America.....         | 756                |
| Amplitone Products Company.....           | 760                |
| Approved Technical Apparatus Co.....      | 748                |
| Arcturus Radio Tube Company.....          | 744                |
| Arrow Sales Company.....                  | 756                |
| <b>B</b>                                  |                    |
| The Brush Development Company.....        | 750                |
| Burstein-Applebee Company.....            | 758                |
| <b>C</b>                                  |                    |
| Capitol Radio Engineering Institute.....  | 759                |
| Central Radio Laboratories.....           | 757                |
| Cinaudagraph Corporation.....             | 750                |
| Classified Section.....                   | 767                |
| Consolidated Wire & Associated Corps..... | 752                |
| Cornell-Dubilier Electric Corporation     | Inside Front Cover |
| Coyne Electrical School.....              | 707                |
| Crosley Radio Corporation.....            | 759                |
| <b>D</b>                                  |                    |
| The Data Print Company.....               | 748                |
| <b>E</b>                                  |                    |
| Foto-Craft Magazine.....                  | 763                |
| <b>H</b>                                  |                    |
| Hammrnlund Mfg. Company.....              | 752                |
| Hudson Specialties Company.....           | 754                |
| Hygrade Sylvania Corporation.....         | 754                |
| <b>I</b>                                  |                    |
| International Resistance Company.....     | 768                |
| <b>L</b>                                  |                    |
| Lafayette Radio Corporation.....          | 753, 765           |
| Lancaster, Allwine & Rommel.....          | 760, 765           |
| Lincoln Engineering School.....           | 754                |
| <b>M</b>                                  |                    |
| Meissner Manufacturing Company Back Cover |                    |
| Miles Reproducer Company, Inc.....        | 754                |
| Modell's.....                             | 758                |
| <b>N</b>                                  |                    |
| National Plans Institute.....             | 766                |
| National Radio Institute.....             | 705                |
| National Schools.....                     | 761                |
| National Union Radio Corp.....            | 757                |
| New York YMCA Schools.....                | 760                |
| <b>O</b>                                  |                    |
| D. W. Onan & Sons.....                    | 760                |
| <b>P</b>                                  |                    |
| Parke Radio Service.....                  | 756                |
| <b>R</b>                                  |                    |
| Radio & Technical Publishing Co.....      | 760, 761           |
| Radio City Products Company.....          | 763                |
| Radio Training Association.....           | 747                |
| Radolek Company.....                      | 767                |
| RCA Institutes, Inc.....                  | 756                |
| RCA Manufacturing Company, Inc.....       | 751                |
| Readrite Meter Works.....                 | 752                |
| Remington Rand, Inc.....                  | 761                |
| John F. Rider.....                        | 754                |
| <b>S</b>                                  |                    |
| E. H. Scott Radio Laboratories.....       | 746                |
| Solar Manufacturing Company.....          | 750                |
| Sprague Products Company.....             | 758                |
| Sprayberry Academy of Radio.....          | 763                |
| Superior Instruments Company.....         | 736, 737           |
| Supreme Instruments Corporation.....      | 747                |
| <b>T</b>                                  |                    |
| Technifax.....                            | 763                |
| Triplett Electrical Instrument Co.....    | 755                |
| <b>U</b>                                  |                    |
| United Radio Company.....                 | 754                |
| Universal Microphone Co., Ltd.....        | 758                |
| <b>W</b>                                  |                    |
| Wellworth Trading Company.....            | 756, 766           |
| Weston Electrical Instrument Corp.        | Inside Back Cover  |
| Wholesale Radio Service Co.....           | 765                |
| Williams Philco, Inc.....                 | 754                |
| Wright-DeCoster, Inc.....                 | 765                |

(While every precaution is taken to insure accuracy, we cannot guarantee against the possibility of an occasional change or omission in the preparation of this index.)

Please Say That You Saw It in RADIO-CRAFT

# "This repair was a headache

... until I used  
the new **WESTON Model 669**  
**VACUUM TUBE VOLTMETER**  
and **SIGNAL DETECTOR**"



Serviceman tells how he  
**SAVES TIME—ELIMINATES  
CALL BACKS . . .** with this  
inexpensive instrument

"We had made four unsuccessful attempts to isolate the intermittent noise in this 15 tube receiver with thorough point-to-point checking. We wasted much valuable time, and had a dissatisfied customer on our hands. Finally, we got a new WESTON Model 669 equipped with phone jack and located the trouble in a few minutes. We connected our Model 776 Oscillator to the antenna and sent a modulated 600 kc signal into the receiver. Using the earphones in the Model 669, we got a steady signal in both the RF and first detector stages. Everything else checked, until we got to the second stage of the bass channel. When we placed the 669 on the plate, a slight crackle came across with the signal, even though the meter reading was okay. Here we found the condenser responsible for the noise, and we were able to quickly clear up the reproduction. From now on, audible tests with the 669 will be a regular part of our testing procedure."



MEASURE  
THE  
SIGNAL

HEAR  
THE  
SIGNAL

only  
**\$50<sup>63</sup>**

NET TO SERVICEMEN  
IN U.S.A.  
(HEADPHONES  
NOT INCLUDED)

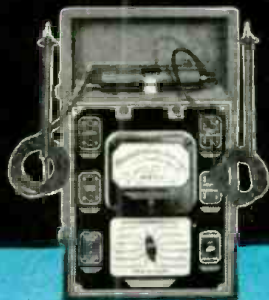

#### MODEL 772—5000 VOLT TELEVISION AND RADIO ANALYZER

Sensitivity 20,000 ohms-per-volt. • Input impedance 100 megohms on top range. • Specially designed low-leakage jacks. • Breakdown voltage in accordance with A.I.E.E. safety standards...11,000 volts. • Current readings down to 1/2 microampere.

NOTE—present owners of 20,000 ohms-per-volt analyzers can bring them up-to-date with the compact WESTON 5,000 volt Televerter...an inexpensive multiplying unit which fits the carrying case.



#### MODEL 787 ULTRA HIGH FREQUENCY OSCILLATOR

Essential for television. Frequency—continuous range 22 to 150 megacycles—no band switching. All frequencies fundamental. High order of stability and resetability over entire range. Equipped for television modulation. Battery operated (self contained). Used with rod antenna (included) or with standard output leads. Small size, light weight, provides extreme portability.

Remember, too, that Model 669  
is an essential tool for servicing  
television. Let us send all  
the facts. Return the  
coupon below.

Weston Electrical Instrument Corporation  
599 Frelinghuysen Ave., Newark, N. J.  
Send bulletin describing the Model 669 Vacuum Tube Voltmeter and other WESTON Instruments.

Name \_\_\_\_\_  
Address \_\_\_\_\_  
City \_\_\_\_\_ State \_\_\_\_\_

# YOU'LL BE PROUD TO SAY

# "I Built It!"

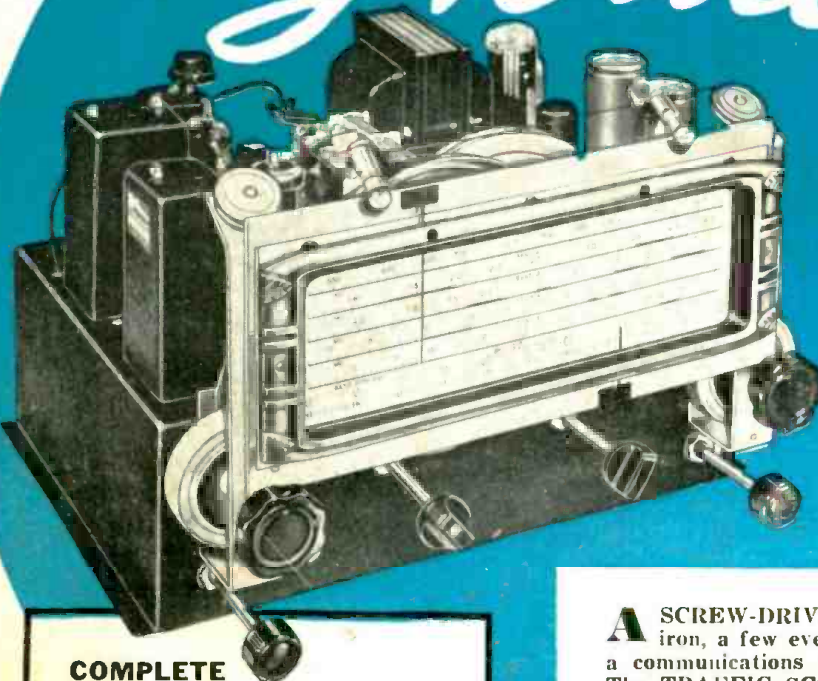

## 8 Tube Traffic Scout Communications Receiver Kit

### COMPLETE KIT OF PARTS

Includes the following: Pre-aligned 5-band Coil Assembly; 3-gang electrical band-spread tuning condenser; band-spread dial and escutcheon; punched and drilled chassis; Ferrocart (Iron Core) I. F. transformers; B. F. O. transformer; volume and tone controls; electrolytic, paper and mica condensers; resistors; miscellaneous small parts; screws, nuts, washers, etc.; hookup wire; solder; complete pictorial and schematic diagrams as well as clearly written instructions for assembling, wiring and operating. (Parts Kit does not include Panel or Cabinet.)

### HOW TO BUILD RADIO RECEIVERS



### NEW!

120 PAGE  
COMPLETE  
INSTRUCTION  
BOOK!

Packed with theory and technical data. Easy-to-understand graphs, charts, pic-

torial and schematic diagrams, alignment data, constructional data and operating instructions for 20 new Meissner receiver kits. Also information on adapters, converters. At your Parts Jobber—or order direct. Address Dept. RC-6

**A** SCREW-DRIVER, a pair of pliers, a soldering iron, a few evenings of real fun—and you have a communications receiver that you'll brag about. The TRAFFIC SCOUT has all the most desirable amateur features—covers 530 KC. to 32.4 MC. (9.25 to 565 meters) in 5 bands: 530—1575 kc., 1.51—4.6 mc., 4.18—12.5 mc., 7.3—18.5 mc., 11.2—32.4 mc. Has the new Meissner electrical bandspread and flywheel tuning, Ferrocart (iron core) I.F. Transformers, and full vision Slide Rule Dial.

Every detail has been simplified by the Meissner engineers to make this receiver easier to assemble. The coil assembly is fully wired and mounted on the wave-change switch ready for use, completely air-tuned and pre-aligned. The chassis is factory drilled—all you need do is connect the parts terminals with hook-up wire according to the detailed and easily ready pictorial wiring instruction sheets and you have a receiver with unexcelled performance, one you'll be proud to put through its paces. And it's guaranteed to work or we'll fix it for you!

See the TRAFFIC SCOUT at your Parts Jobber, or write Dept. RC-6 at the factory. Ask for FREE 44-page catalog describing AC and Battery operated Meissner Kits from 1 to 14 tubes.

# Meissner

MT. CARMEL, ILLINOIS

"A FAMOUS NAME FOR TWO DECADES"